

The City and County of Swansea
(Hafod Air Quality Management Area (NO₂))
Order 2001

Action Plan



The Environment Act 1995: Part IV
Local Air Quality Management

Title	City & County of Swansea Hafod Air Quality Management Area Action Plan
-------	---

Address	Mrs Reena Owen, Director of Environment, City & County of Swansea, Countyhall, Swansea.
---------	---

Date	December 2004
------	---------------

	Name	Designation	Signature	Date
Data Analysis and Reporting	Mr P.J.Govier	Environmental Management Systems Development Officer		
Reviewed and Authorised	Mr H.Morgan	Divisional Pollution Control Officer		

Contents

	Page Number
1. Introduction	1
1.1 Background to Air Quality Legislation	3
1.2 The Review and Assessment process	3
2. The Hafod Air Quality Management Area	6
2.1 The “problem area”	6
2.2 Census Data	28
2.3 Topography and Road Network of the Lower Valley Area through the Hafod district	30
3. Existing Strategies and Consultation	35
3.1 The City and County of Swansea Local Transport Plan (LTP) 2000-2005	35
3.2 Land Use Development and the LTP	40
3.3 The Hafod Integrated Transport Study	43
3.3.1 Traffic Management Options Appraisal	44
3.3.2 Measures to be taken forward from the Options Appraisal process	52
3.3.3 The Consultation Process	53
3.3.4 Detailed Traffic Management Proposals	58
3.3.4.1 Highway Improvements	58
3.3.4.2 Pedestrian Improvements	61
3.3.4.3 Parking provision along Neath Road	62
3.3.4.4 Bus stop provision	62
3.3.4.5 Cycle routes	63
3.3.4.6 Gateway treatments	64
3.3.4.7 Traffic Control Point	64
4. Proposed Additional Measures	67
4.1 Park and Ride Provision	67
4.1.1 Landore Park and Ride	69
4.1.2 Port Tennant Park and Ride	70
4.1.3 Proposed Fforestfach Park and Ride	71
4.2 Improved Bus provision	71
4.2.1 Bus Corridor Enhancements	72

4.2.2	Enhancement of Bus and Rail Stations	74
4.3	Safe Routes to School	75
4.4	Vehicle Emissions Testing	80
4.5	City Centre Car parking	80
4.6	Travel Plans	82
4.7	Enforcement of Bus Only Lanes	84
4.8	City & County of Swansea Vehicle Fleet	85
4.9	Quay Parade Bridges	86
4.10	Cycle Provision	87
4.11	Local rail and Long Distance Rail Services	91
4.12	Taxi Services	92
5.	Traffic Management Systems with Air Quality Monitoring Feedback – Nowcasting – Computer Modelling and Traffic Management	94
5.1	Overview	94
5.2	Data Requirements – a brief overview	95
5.3	Predictive Output	99
6.	Action Plan Consultation	102
7.	Summary of Actions and Cost Benefit	105

Annexe 1 – Origin-Destination Surveys

Annexe 2 – Action Plan Consultation Leaflet 1

Annexe 3 - Action Plan Consultation Leaflet 2

1. Introduction

This report forms the basis of this authorities obligation under section 84 of the Environment Act 1995 to produce a written plan in pursuit of the achievement of air quality standards and objectives within the designated Hafod Air Quality Management Area.

The structure and contents of the report is intended to provide as much detail as possible on the numerous complex and inter linked strategies and action points. This introductory chapter outlines the review and assessment process up to this point and draws attention to some of the key points.

Chapter 2 deals with the identified problem area. This chapter outlines the measures taken during the previous review and assessment stages that have lead to its identification. Mentioned within this chapter is the complex topography that contains the road infrastructure network of the lower Swansea Valley area that is the source of the predicted nitrogen dioxide exceedences in 2005. The chapter identifies areas that whilst outside of the immediate problem area, will prove crucial in the success of the plan as a whole. In particular, the situation at Quay Parade bridges is mentioned throughout this document and is briefly outlined further within chapter 4.9.

The Action Plan builds on the comprehensive work that has already been undertaken by the authority in developing the Local Transport Plan and Unitary Development Plans. Chapter 3 outlines the measures taken in preparation and formulation of both of these plans. Both plans have been the subject of extensive consultation processes.

The Hafod Integrated Transport Study also contained within chapter 3 is a study of traffic management within the problem area. The study identifies traffic management options following extensive consultation with local stakeholders and residents. As a direct result of the appraisal process, detailed traffic management proposals have been put forward. The benefits and anticipated costs of implementing these proposals are discussed briefly in chapter 7 which collates the various action points and proposals detailed throughout the plan within one chapter.

Chapter 4 expands on measures either currently underway or proposed from the measures contained within the Local Transport Plan which are seen as vital and complementary to this plan.

In order to build upon the traffic management proposals contained within the Hafod Integrated Transport Study a wider bespoke traffic management system is being constructed. This system will enable computer modelling of predicted conditions within each identified road link every hour for up to 8 hours in advance of the conditions actually occurring. Computer models are being developed to this authority's specific requirement to interact with other bespoke systems such as variable message signs, automatic traffic counters and meteorological forecasts. Specific messages will be broadcast to variable message signs in an attempt manage the traffic flows prior and during predicted pollution episodes. The data requirements of the models is extensive and has required amongst other things, the development of a sophisticated network of traffic counters within the lower Swansea Valley Area. Details on this work can be found in chapter 5. Again, the costs and benefits of these developments are mentioned within chapter 7.

Chapter 6 outlines the consultation measures undertaken in respect to the whole Action Plan. Examples of the consultation leaflets produced are included within Annexe 2 and Annexe 3

1.1 Background to Air Quality Legislation

Part IV of the Environment Act 1995 required the production of a national strategy for air quality. The same Act places a duty on local authorities to carry out periodic reviews of air quality to determine if they will meet the objectives set out in the National Air Quality Strategy (NAQS). The National Air Quality Strategy was first published in March 1997 with the Air Quality Regulations providing the legal footing for the air quality objectives set out in the NAQS. The NAQS uses health-based standards to control the levels of seven designated air pollutants.

The NAQS has evolved over time and has seen the NAQS revised and republished as “The Air Quality Strategy for England, Scotland, Wales and Northern Ireland – Working Together for Clean Air”. The revision integrated European air quality standards into UK policy and, eventually legislation for both England and the devolved administrations. In Wales the Air Quality Regulations 1997 have been superseded by the Air Quality (Wales) Regulations 2000.

1.2 The Review and Assessment Process

The local authority review and assessment process is multi-staged. This Authority carried out its first stage review in 1999. The conclusion reached was

to progress to a second and third stage review for Benzene, Particulate Matter (PM₁₀), Sulphur Dioxide (SO₂) and Nitrogen Dioxide (NO₂).

Along with all other local authorities, this authority has completed its stage 2 and stage 3 reviews. The third stage review and assessment concluded that despite the indication that the air quality objective for benzene would not be met, that the declaration of an AQMA was not appropriate. Given the fundamental changes proposed to the Lower Swansea Valley's infrastructure and the technical improvements proposed in the reduction of the benzene content in fuel, it was recommended that a further benzene monitoring study be carried out for a period of at least 12 months. During the stage 3 process, it was determined that the authority would not breach the objectives laid down for Particulate Matter (PM₁₀) and Sulphur Dioxide (SO₂).

Section 83(1) of the Environment Act 1995 requires the Authority to designate as Air Quality Management Areas (AQMA's) those areas where it is likely that the standards for any of the identified pollutants would be exceeded. As a result of the detailed work carried out in the authority's third stage review and assessment it was found that areas of the Hafod were likely to fail the NO₂ annual mean objective of 40µg/m³ by the compliance date of 31st December 2005.

On the 12th September 2001 the Authority declared The Hafod Air Quality Management Area (NO₂), cited as the City & County of Swansea (Hafod Air Quality Management Area (NO₂)) Order 2001. The Order came into force on the 14th September 2001. A map outlining the area covered by the order can be seen in Appendix 1.

Section 84(1) of the Environment Act 1995 requires an authority which has designated an area as an AQMA, to carry out additional monitoring to determine

if the original decision to declare the AQMA was based on sound knowledge and to further refine and quantify the improvements needed.

Section 84(2)(a) states that a report of the results of this assessment should be completed:

“before the expiration of the period of twelve months beginning with the coming into operation of the..... City & County of Swansea (Hafod Air Quality Management Area (NO₂)) Order 2001.”

This assessment has become known as the Stage 4 Review and Assessment of Air Quality report. The authority completed its Stage 4 review in October 2003.

As can be seen, the City and County of Swansea failed to comply with this deadline in submitting its Stage 4 report to the Welsh Assembly Government. The City and County of Swansea took the view that this Stage 4 review could best be addressed in parallel with its obligations under section 84 of the Environment Act 1995. Section 84 requires the formulation of a written plan in pursuit of the achievement of air quality standards and objectives within the designated AQMA and has become known as the “Action Plan”. The recognition by this authority that to satisfy both obligations would require a considerable amount of planning and consultation has led to this delay. Much feasibility and preparatory work has been carried out and the City and County of Swansea are now satisfied that the outcome will result in a workable Action Plan that will attempt a feasible delivery of the improvements required.

2 The Hafod Air Quality Management Area

2.1 The “problem area”

The method of assessment and approach carried out during the authority’s stage 4 review was to monitor rather than model due to the lack of suitable traffic flow data etc. A 50 site passive nitrogen dioxide tube study was undertaken for a whole year between April 2001 and March 2002 and focused on the road infrastructure of the lower Swansea Valley as a whole. In addition passive NO₂ diffusion tube results were considered from the Hafod Post Office site on Neath Road, Hafod. This site participates in the UK Non-Automatic (NO₂) Network and supplies data on a weekly and monthly basis to the network. The monthly results were analysed from 1993 – 2003 to produce annual means. The resultant annual means can be seen in table 1 below.

Year	Measured NO ₂ Annual Mean µg/m ⁻³	Corrected Annual Mean µg/m ⁻³ **
1993	65	50.3
1994	61	47.3
1995	73	57.1
1996	65	51
1997	59	45.7
1998	55	42.6
1999	69	53.7
2000	61	47.5
2001	61	47.3
2002	66	51.5
2003	69	53.7

*** Corrected means obtained by applying bias factor of 0.78 as advised by Harwell Scientifics Ltd*

Table 1. Hafod Post Office Site NO₂ Tubes Annual Means 1993-2003.

As can be seen from table 1, the NO₂ annual mean has remained fairly consistent over the past 10 years. This assumption does not take account for any changes in analytical methods or variance from laboratory operating procedures over the years.

The Hafod Post Office site was used in the weekly passive diffusion tube study carried out by this authority between April 2001 and March 2002. In this study the Post Office site is referred to as site 27. If the monthly diffusion tube data from the UK Non Continuous Swansea 1N Hafod Post Office Site is compared with the weekly diffusion tube data from the survey carried out by this authority, a good correlation between the two can be seen. The monthly sampling period annual mean between the above dates is 64µg/m⁻³ (uncorrected) whilst the annual mean obtained from the weekly survey undertaken during 2001/2002 is 65.7µg/m⁻³ (uncorrected). This slight discrepancy can probably be taken to be as a result of the slight differences in the start and end times of the relevant periods but overall a very good match can be seen.

The results of the weekly NO₂ passive diffusion tube study between April 2001 and March 2002 showed that after correction for tube bias, nine sites remained above the annual mean 40µg/m⁻³ objective as set in the Air Quality (Wales) Regulations 2000. Three other sites are in the corrected range of 39-40µg/m⁻³ and these sites were also taken to be failing the annual mean objective. Tube bias was taken to be 0.78 as advised by Harwell Scientifics Ltd.

These failing sites are shown below in table 2

X-coord	Y-coord	Site ID	Weekly Min	Weekly Max	Weekly SD	Raw Data Annual Mean	Weekly Data Loss	BIAS Corrected Annual Mean	CV%
265919	194463	27	43.2	82.8	8.5	65.7	0	51.3	13.3
265831	194243	30	34.1	75.1	9.9	50.4	1	39.3	19.8
265610	194234	34	29.2	87.0	13.4	55.8	1	43.5	23.9
265494	194233	35	28.9	102.4	19.2	59.3	4	46.2	32.3
264968	194739	36	37.5	81.0	10.9	54.1	1	42.2	20.1
264524	195383	37	25.6	71.9	10.1	50.6	0	39.5	19.7
265551	193999	38	30.9	72.3	11.9	55.2	2	43.1	21.7
265718	193871	39	30.4	97.0	12.9	50.9	0	39.7	25.4
265855	193701	41	28.1	89.0	13.2	58.6	1	45.7	22.3
265596	193397	43	29.8	88.5	13.4	53.0	1	41.3	24.7
265645	193376	44	22.7	84.4	11.5	62.8	0	49.0	17.7
266204	193596	48	26.4	112.5	13.5	55.6	1	43.3	23.8

Table 2 – Stage 4 review – Sites failing annual mean objectives

Of these 12 failing sites 9 are located either within, or are on the boundary of, the City & County of Swansea (Hafod Air Quality Management Area (NO₂)) Order 2001. Their locations can be seen in map 1 below.

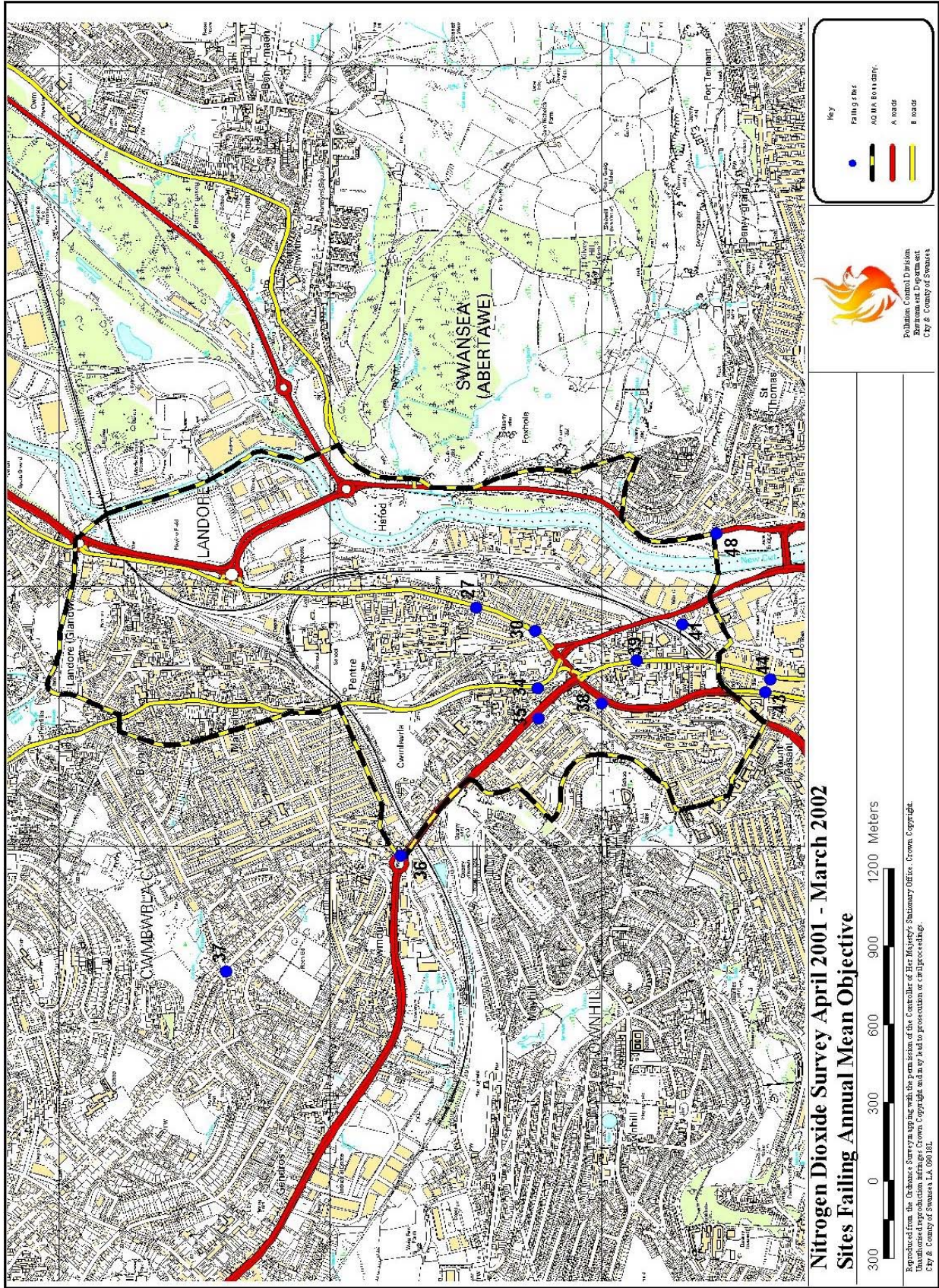

Map 1 – Nitrogen Dioxide Survey April 2001- March 2002 – Sites failing annual mean objective

These results were projected forward to 2005 using NETCEN's Air Pollution Year Adjustment Calculator version 1.1a dated 14th November 2002. After applying the prediction for 2005, the number of sites that are predicted to breach the 40µg/m⁻³ objective has fallen to five and can be seen below in table 3. There are another two sites in the predicted range of 39 - 40µg/m⁻³ and it has been assumed that these are also likely to fail the annual mean objective.

X-coord	Y-coord	Site ID	Site Classification	Raw Data Annual Mean	Weekly Data Loss	BIAS Corrected Annual Mean	2005 Prediction
265919	194463	27	R	65.7	0	51.3	47.22
265831	194243	30	R	50.4	1	39.3	36.18
265610	194234	34	R	55.8	1	43.5	40.04
265494	194233	35	R	59.3	4	46.2	42.53
264968	194739	36	R	54.1	1	42.2	38.85
264524	195383	37	R	50.6	0	39.5	36.36
265551	193999	38	R	55.2	2	43.1	39.68
265718	193871	39	R	50.9	0	39.7	36.55
265855	193701	41	UB	58.6	1	45.7	42.65
265596	193397	43	R	53.0	1	41.3	38.02
265645	193376	44	R	62.8	0	49.0	45.11
266204	193596	48	R	55.6	1	43.3	39.86

Table 3 – Prediction of NO₂ levels from measured data for 2005

The 7 sites that are predicted to fail the annual mean objective in 2005 can be seen below in Map 2

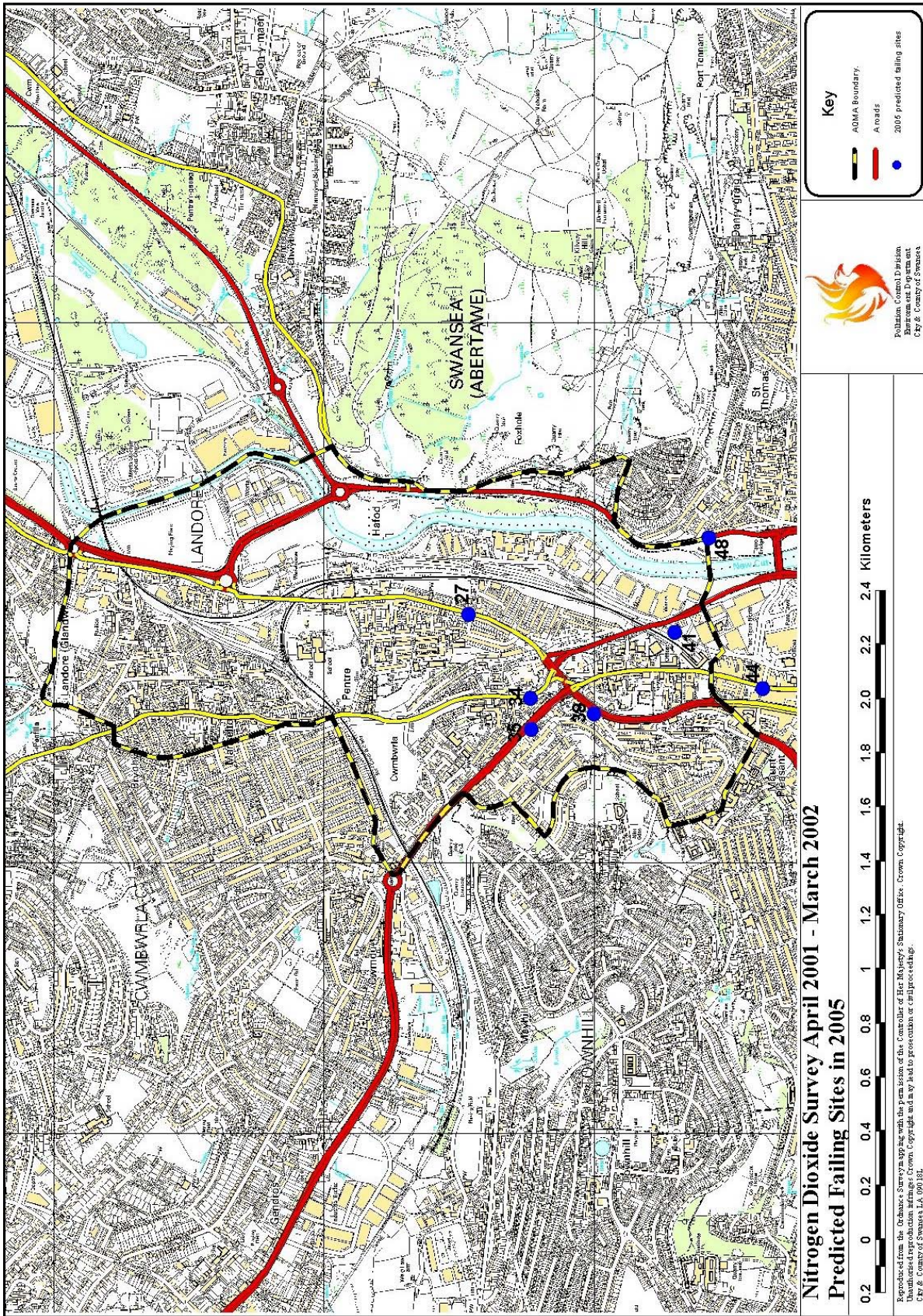

Map 2 – Predicted sites failing NO₂ annual mean objective in 2005

After calculation of the 2005 predictive levels an indication of the reduction in NO₂ can be derived. Table 4 details those reductions required for the identified failing sites only. Sites in the predicted range of levels between 39 - 40µg/m⁻³ in 2005 have been included for completeness and show a negative reduction.

Site Number	Site Classification	2005 Prediction	Reduction Required µg/m ⁻³
27	R	47.22	7.22
34	R	40.04	0.04
35	R	42.53	2.53
38	R	39.68	-0.32
41	UB	42.65	2.65
44	R	45.11	5.11
48	R	39.86	-0.14

Table 4 – Reduction of NO₂ required by site

Of these 7 sites, 6 are located either within or on the boundary of the Hafod AQMA. The site that lies outside of the Hafod AQMA is located within the city centre.

The distribution of the weekly results from the 7 predicted failing sites given in table 4 above were examined and compared to a Normal Distribution (Gaussian) fit curve to provide additional assurance on siting and data validity.

The results obtained can be seen below in histogram plots 1-7. All histogram plots were generated with the Grapher 4 software package from Golden Software Inc. The weekly uncorrected diffusion tube results were placed in bin sizes of incremental increases of 5µg/m⁻³ and the number of weekly results falling into that class size can be seen on the Y axis.

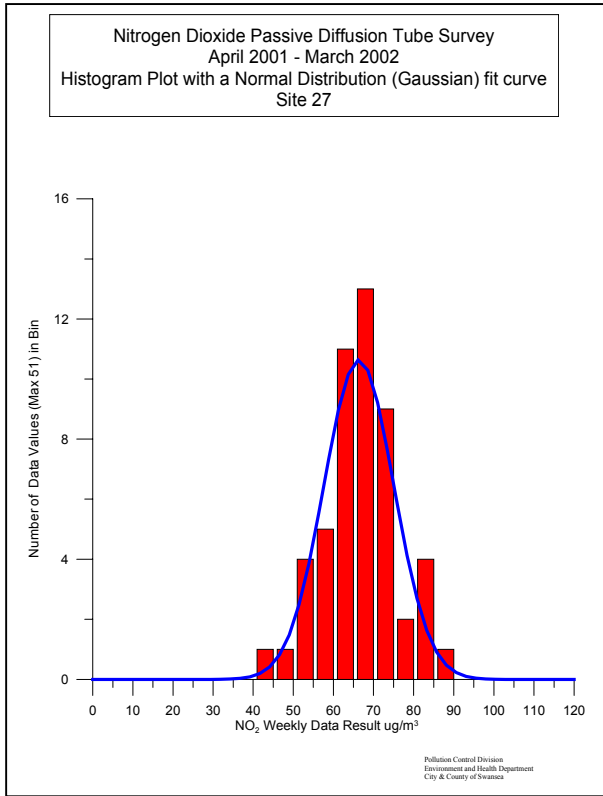

Histogram Plot 1 – Site 27

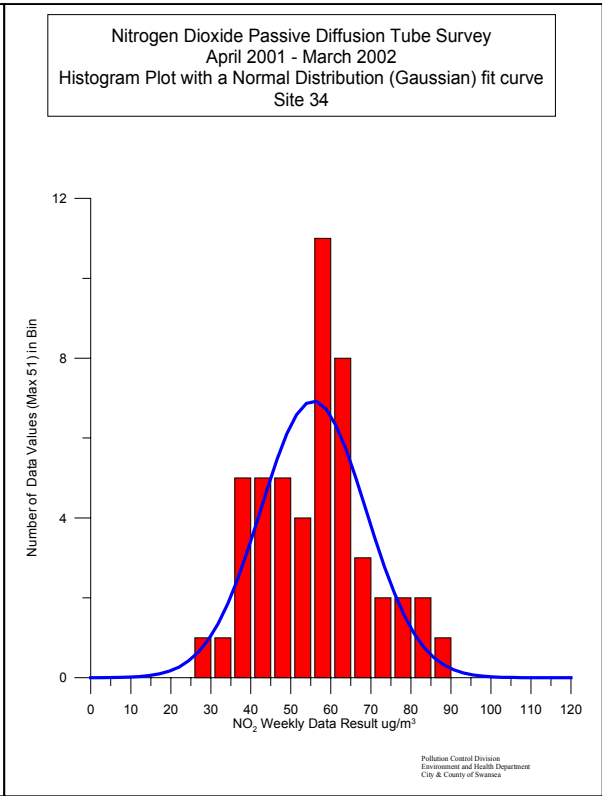

Histogram Plot 2 – Site 34

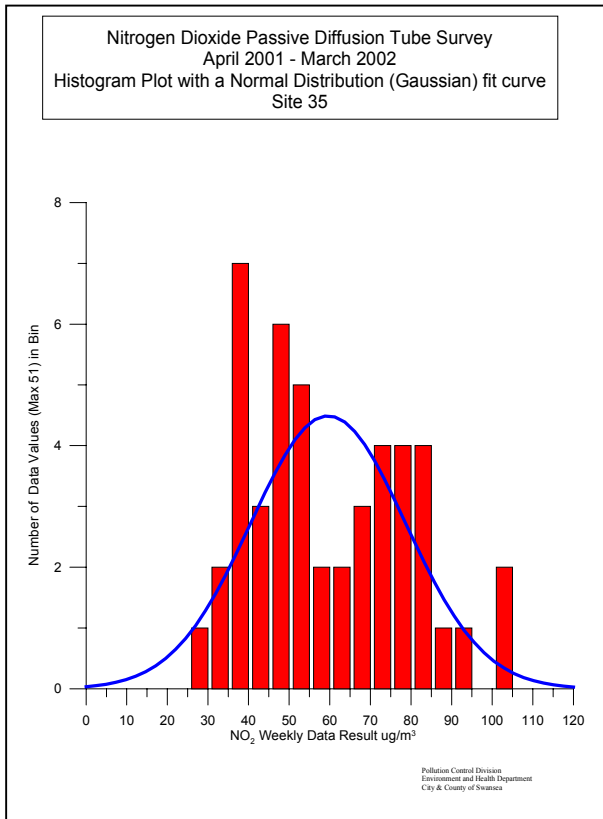

Histogram Plot 3 – Site 35

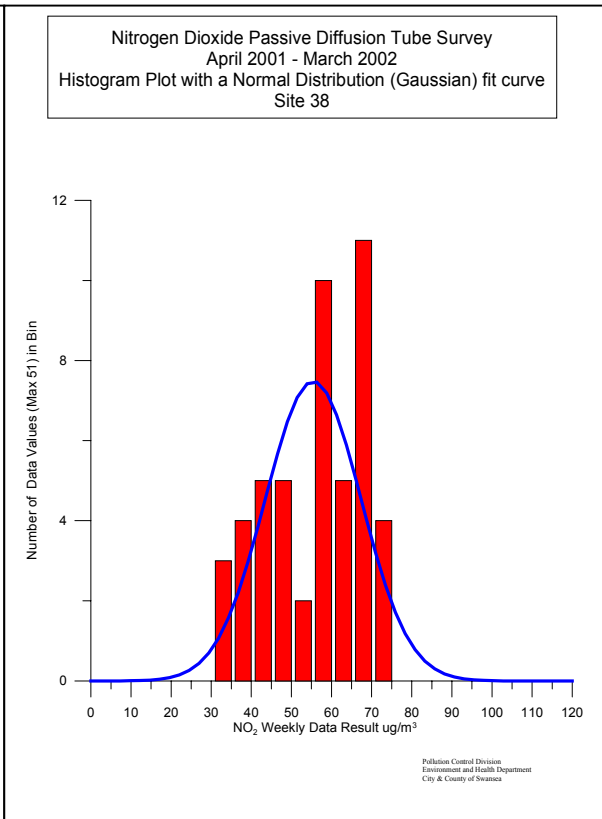

Histogram Plot 4 – Site 38

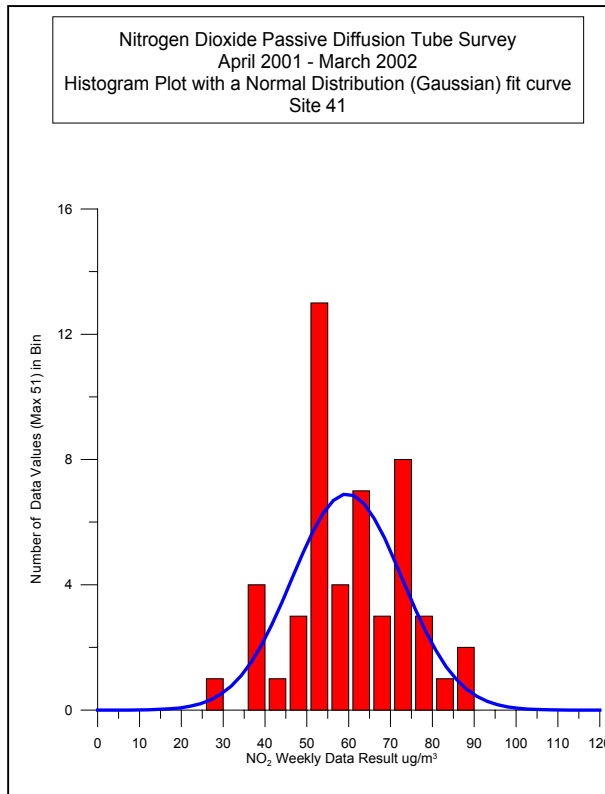

Histogram Plot 5 – Site 41

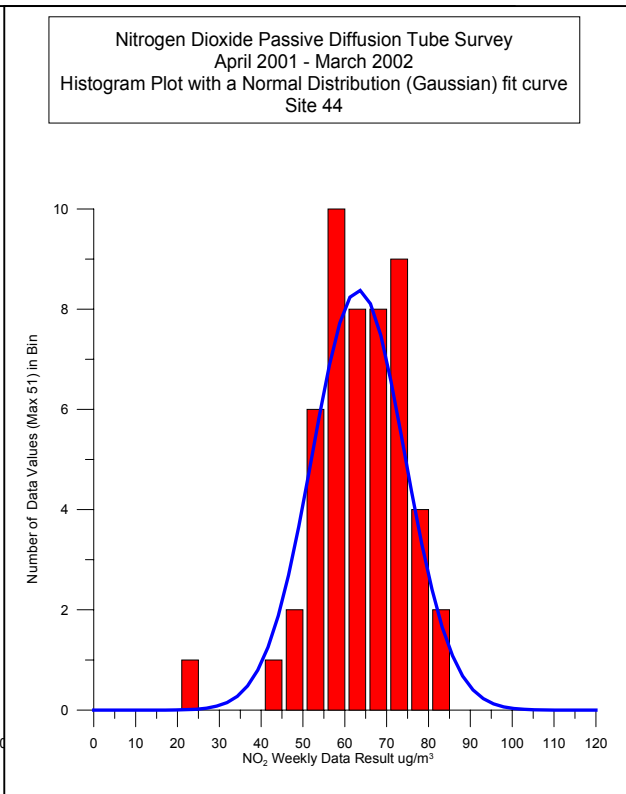

Histogram Plot 6 – Site 44

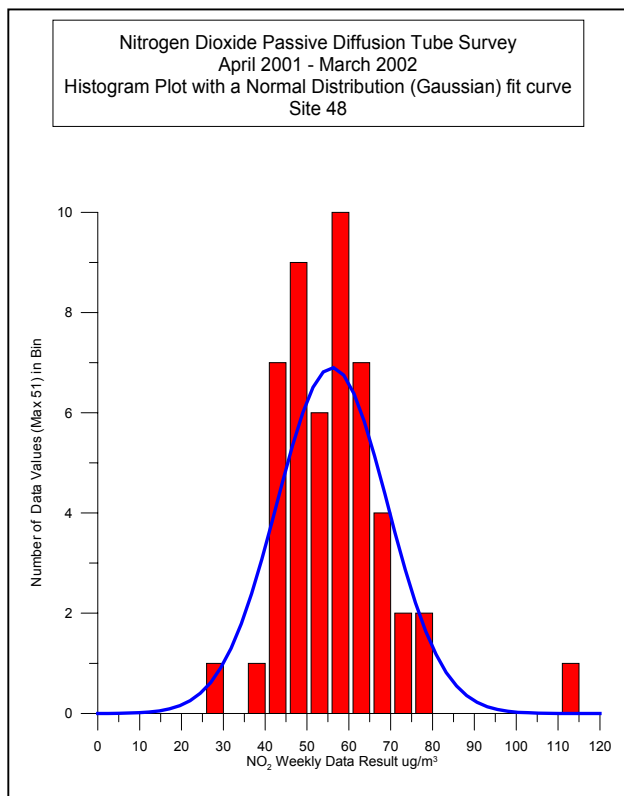

Histogram Plot 7 – Site 48

From the histogram plots produced for sites 27 and 44 a good overall fit to the expected bell curve is obtained. Worse fit was observed with the results from site 35 (histogram plot 3).

The result shown for site 48 (histogram plot 7) that is shown to be within the 110-115 $\mu\text{g}/\text{m}^3$ bin is so far removed from the expected values that it can almost be treated

as an outlier, although no other indications exist to indicate that it should be removed from the dataset.

It was anticipated that a calculation in the reduction in NO_x required at each site would be able to be made, based on the classification made by the Automatic Traffic Counters (ATC's) located throughout the authority's area. However, information received from the Highways Service has established that this is not feasible due to the method of counting employed. The ATC's had only been configured to produce an hourly count of total traffic flow. No vehicle classification is carried out as part of this process. In addition, no indication of speed of the vehicles can be obtained from this data. Therefore, it was felt that it would be both inappropriate and misleading to "guess" at the classification split to indirectly derive emission factors, enabling calculation of the NO_x loading produced from each vehicle classification. Use of the projected UK vehicle fleet composition was considered to produce a classification split but was eventually discounted due to the inherent uncertainties from using and basing judgements on the underlying data.

The situation regarding the ATC's had already been identified during the Stage 3 Review and Assessment process and has now been addressed. Funding has been allocated to purchase 40 new GPRS ATC's. These have now been ordered and installation commenced within the boundary of the Hafod AQMA during October 2003. Additional details on these GPRS ATC's can be found in chapter 5.

One important observation from this study has been the impact that an easterly wind direction imposes on the lower valley area and the AQMA. Previous studies and mapping exercises had shown an influence from industrial sources located to the east of the Swansea conurbation but some of these industrial sources are no longer present and it had been assumed there would no longer be any major influence from this direction. The Corus steelworks at Port Talbot lies to the east of Swansea conurbation and has contributed to local elevated levels

of SO₂ and PM₁₀ during periods of easterly winds at all three continuous real-time monitoring stations within the authorities area (see Map 3). The implications of additional NO_x inputs from this source have probably been masked and are not immediately apparent, as NO_x sources have mainly been attributed to the local transport infrastructure within the valley area.

It is also feasible that a proportion of these NO_x sources emanate from the large conurbations to the east of Swansea and even from outside of the UK and form part of the trans boundary pollution from eastern European countries.

To the main it has been determined that major NO_x inputs within the lower Swansea Valley area are as a result of emissions from the road transport network. This can be demonstrated together with the effect that an easterly wind feed has on the lower valley area by means of plotting NO₂ isopleth concentrations for the winter high concentration week of the 5th – 12th December 2001 - isopleth plot 1. Plot 1 has been generated by the software package Surfer 8 by Golden Software. Isopleth concentrations are uncorrected for tube bias and represent the weekly NO₂ results from each site and are expressed in units of µg/m⁻³. Isopleths are colour coded on a sliding colour scale from blues, indicating lowest concentrations, to red indicating the highest concentrations.

The OPSIS Hafod DOAS station has been established since January 2004 to directly monitor vehicle emissions along a 250-metre section of the congested B4603 Neath Road through the Hafod district.

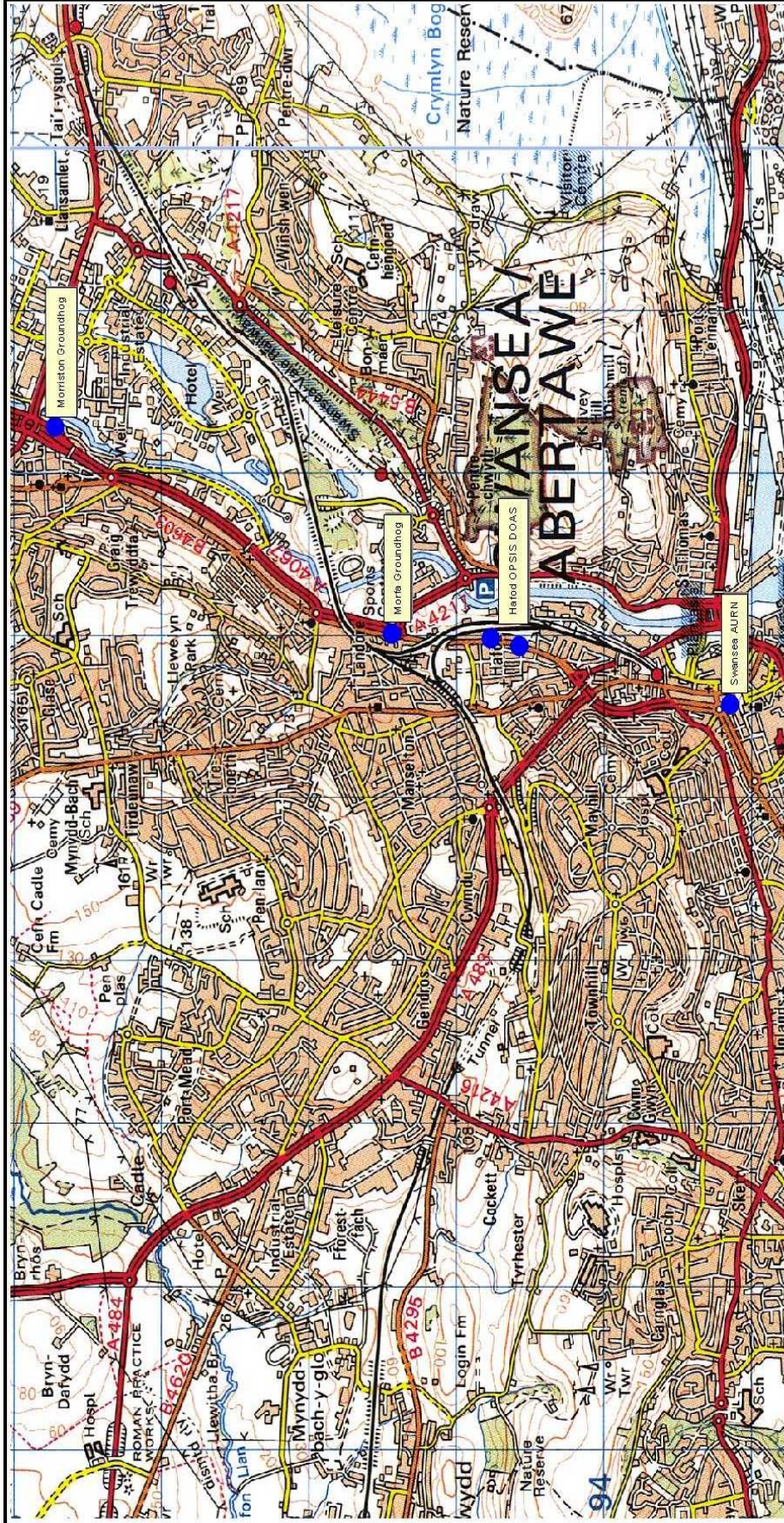

Location of Automatic Real Time Continuous Air Quality Monitoring Stations

Map 3

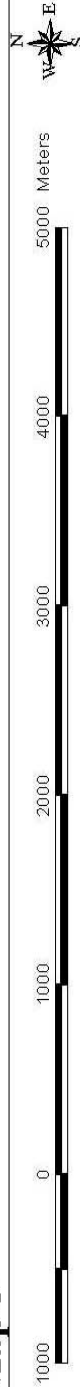

Reproduced from the Ordnance Survey mapping with the permission of the Controller of Her Majesty's Stationery Office © Crown Copyright.
 Unauthorised reproduction infringes Crown Copyright and may lead to prosecution or civil proceedings.
 City & County of Swansea 100013350
 Pollution Control Division
 Environment Department
 City & County of Swansea

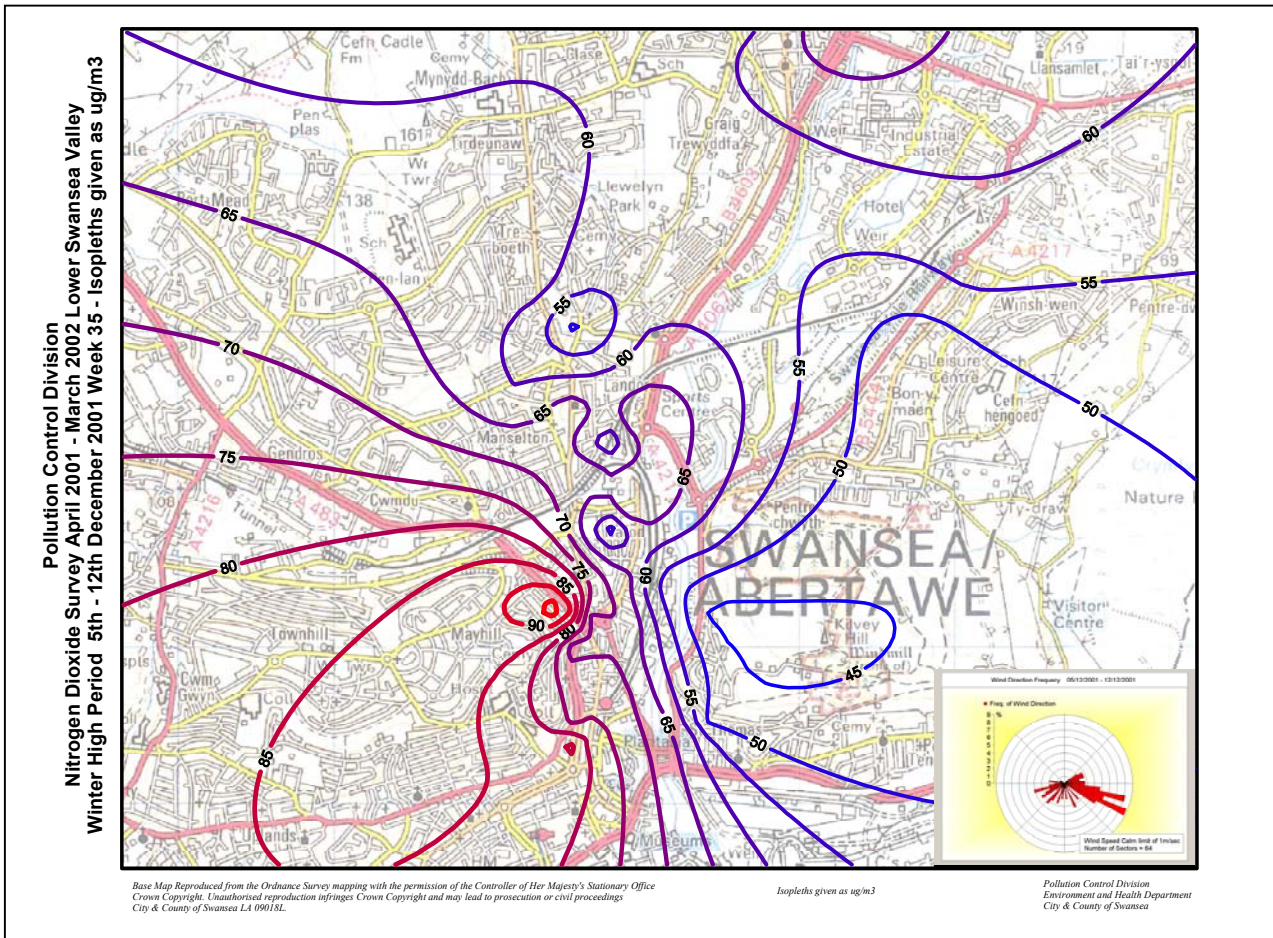

Isolepth Plot 1-Winter High Week 5th – 12th December 2001- Lower Swansea Valley

The winter high week shown in isopleth Plot 1 above demonstrates isopleth concentrations over the majority of the lower valley area for this time frame. To the north of this plot lies junction 45 of the M4 which feeds traffic down the central valley corridor route – the A4067.

Isolepth Plot 2 below focuses in on the Hafod district and at the same time shows the Greenhill/Dyfatty interchange at Carmarthen Road.

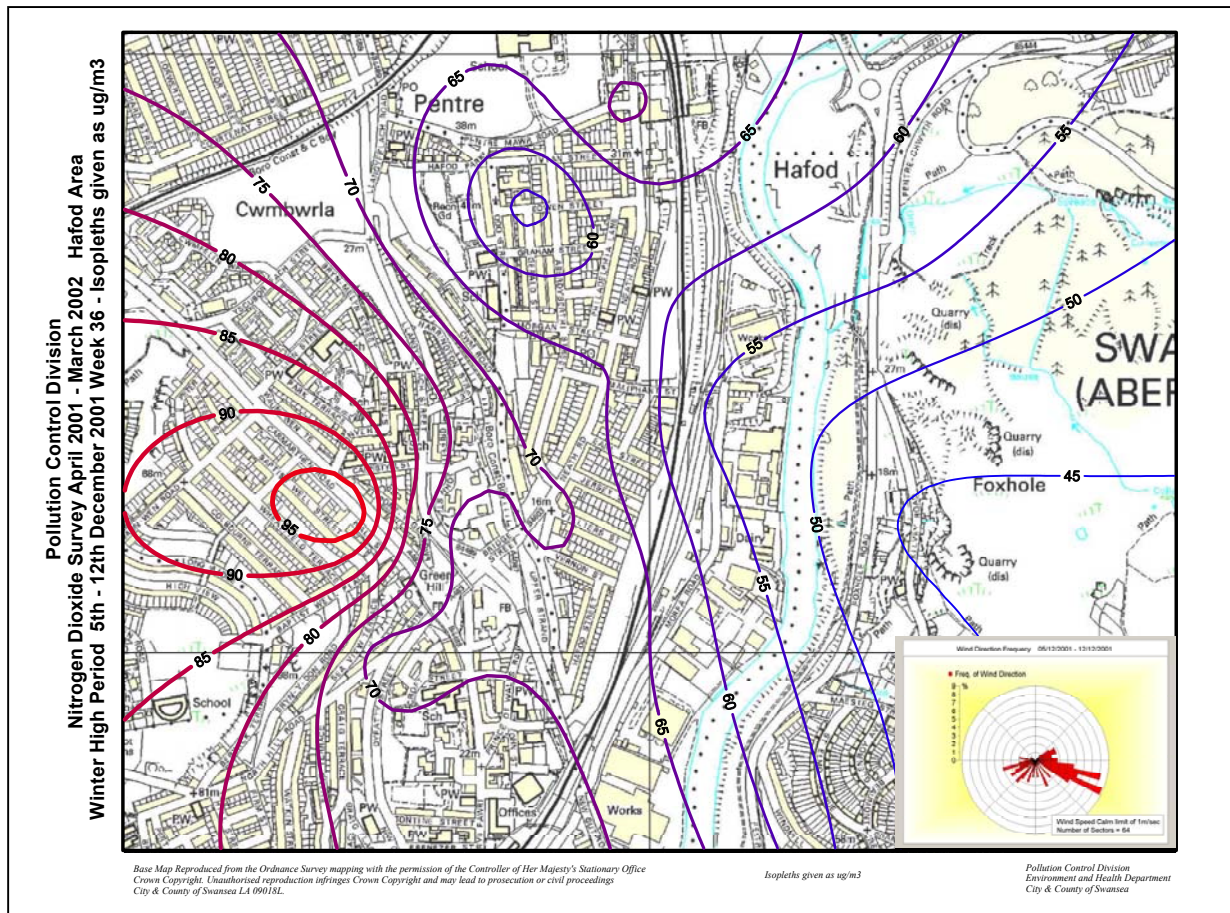

Isoleth Plot 2 – Winter High Week 5th – 12th December 2001 – The Hafod Area

Maximum hourly NO_x and hourly mean NO₂ concentrations recorded at the Morfa Groundhog real-time monitoring station located within the Hafod AQMA have been used to generate Breuer classification plots with the OPSIS Enviman module Reporter for the winter high period 5th - 12th December 2001.

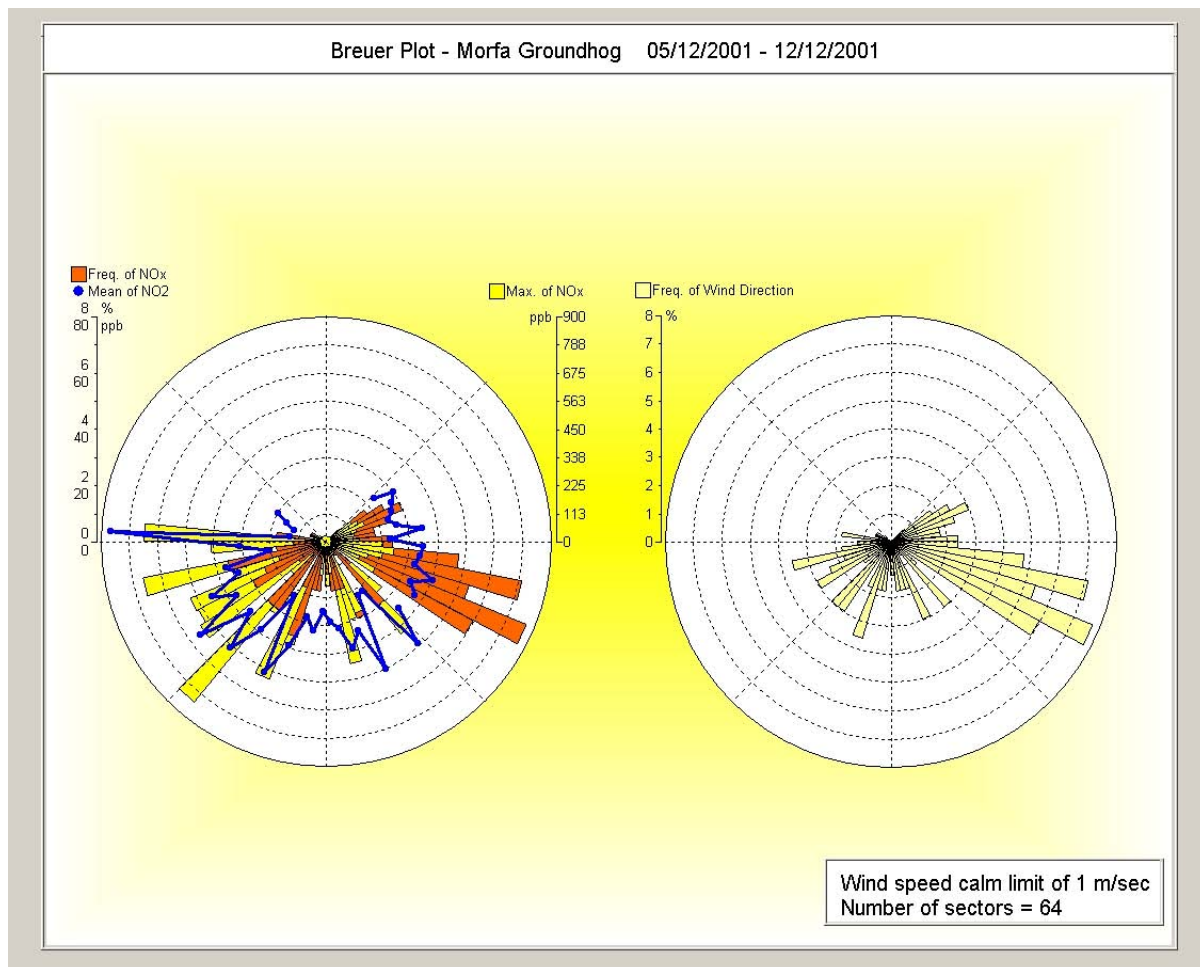

Breuer Classification Plot 1 – Morfa Groundhog NO_x and NO₂ Winter high period 5th -12th December 2001

From Breuer classification plot 1 it can be seen that the frequency of NO_x loadings at the Morfa Groundhog site mirrors the frequency of wind direction. However, what also can be seen is that whilst the frequency of the NO_x inputs occur from the prevailing wind direction as would be expected, it can also be seen that the maximum NO_x ppb readings were not from this prevailing wind direction but from the south west.

Breuer classification plot 1 demonstrates that significant NO_x sources exist from within the lower valley area itself, and that not all of the NO_x inputs originate from the east of the Swansea conurbation under a south-easterly wind flow. There are however, still clearly some NO_x inputs from the south east. These are possibly either due to the heavy industry at Corus steelworks at Port Talbot

and/or the M4 corridor, but are more likely from the major intersection around the Quay Parade bridges/junction at the mouth of the valley and the valley corridor itself.

The topography of the lower valley area (which encompasses the Hafod AQMA) is complex and these features are thought to enhance pollution loadings under certain meteorological conditions. More notably, during wintertime the lower valley area is prone to the formation of inversion layers.

Isopleth plots have been generated on a weekly basis to indicate the spatial variability of NO₂ within the lower valley area on a short term basis. This has shown some marked changes in the spatial patterns of NO₂ from week to week when prevailing meteorological conditions fluctuate. Of more probable use however, are isopleth plots for the winter and summer periods to gain an understanding of the long term spatial variation pattern.

Isopleth and Breuer classification plots were generated for the summer period (April -September 2001) and the winter period (October 2001 – April 2002) and are shown below as isopleth plots 3 and 4.

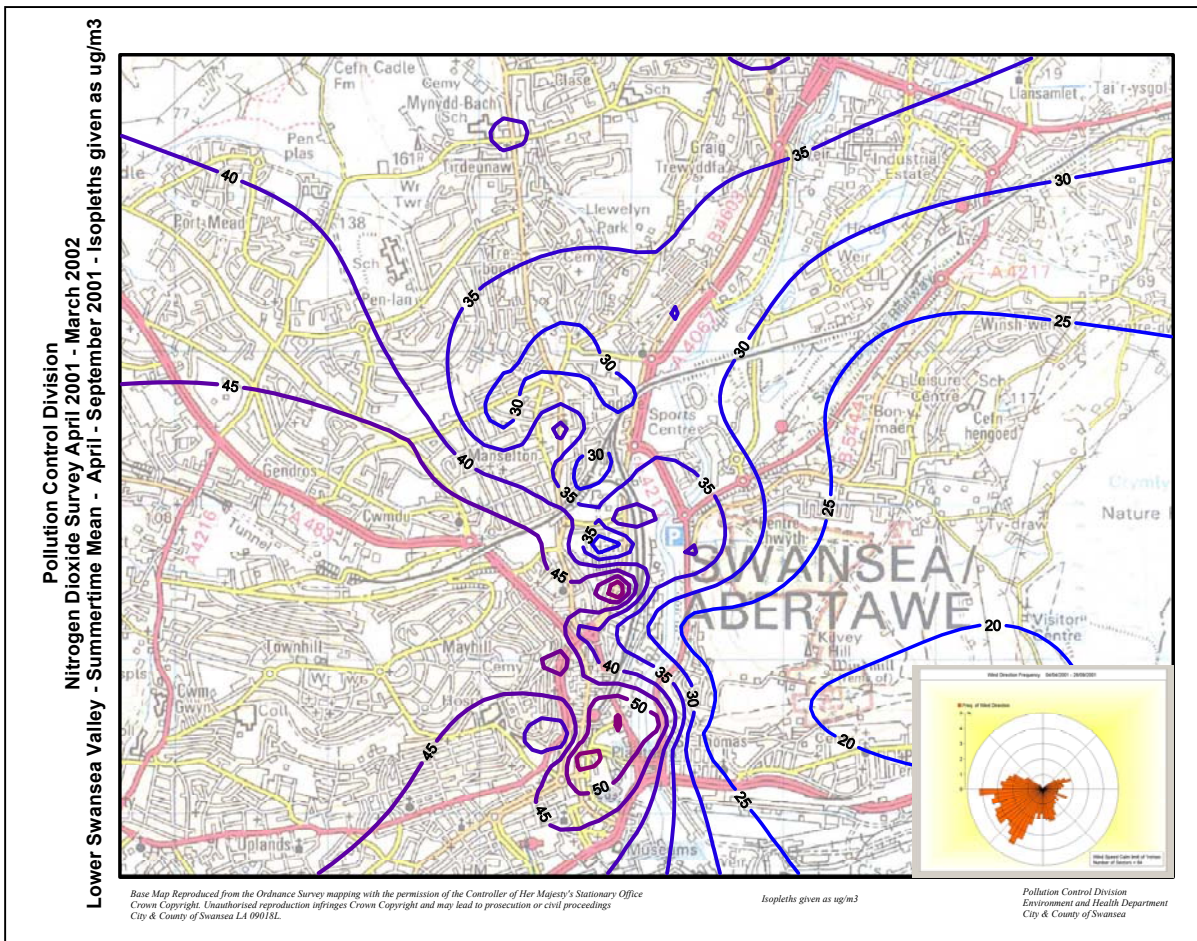

Isopleth Plot 3 – Summer time mean NO₂ concentrations – Lower Swansea Valley

Much the same pattern in NO₂ distribution can be seen as in the whole study period. Isopleth mean concentrations are if anything approximately $5\mu\text{g}/\text{m}^3$ lower than the study means during the summer period. The same general trends in isopleth concentrations are evident around Quay Parade bridges, the Hafod area and the M4 junction 45 at Ynysforgan (to the north of this plot).

For clarity and in order to focus in on the problem area, isopleth plot 4 has been “focused” within the Hafod area to provide spatial averaging robustness as this is where the majority of sample points were located and can be seen below.

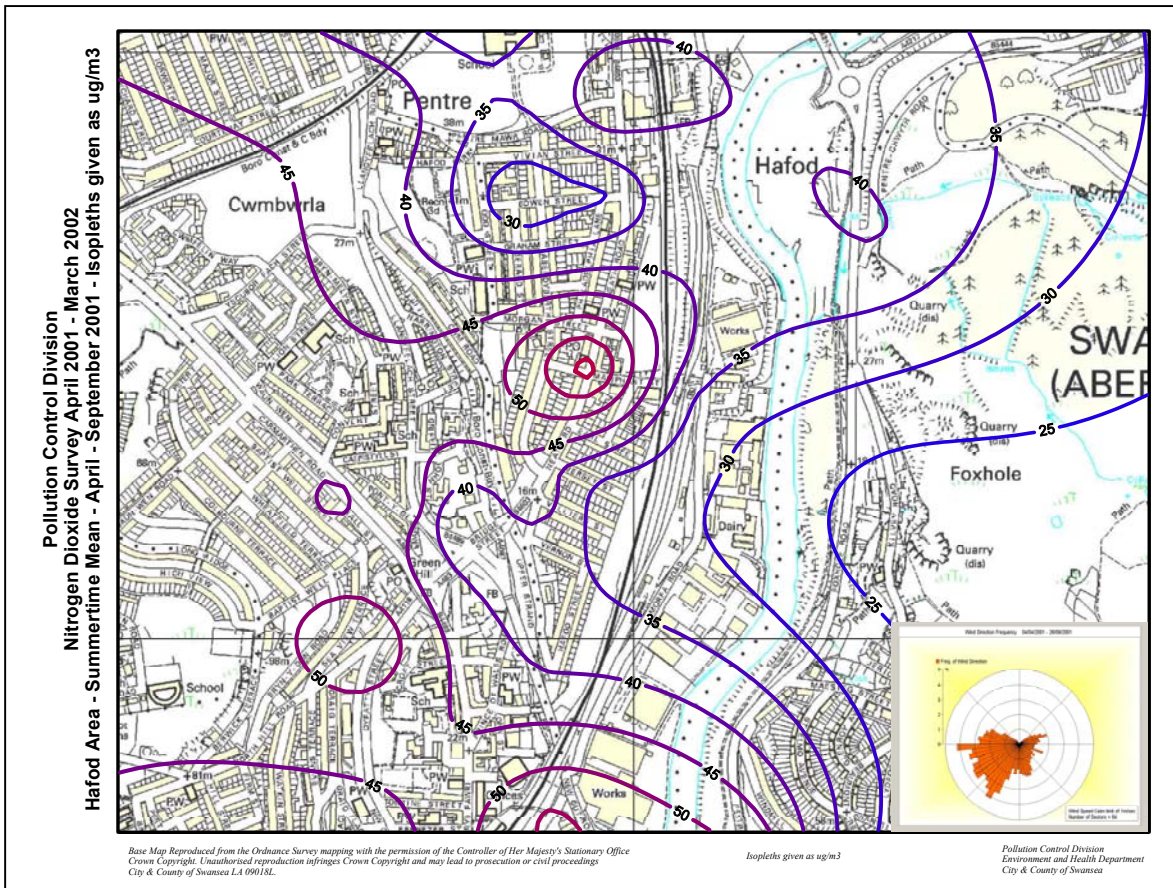

Isoleth Plot 4 – Summer time mean NO₂ concentrations – Hafod Area

The Hafod area now shows three distinct areas of NO₂ concentrations within a relatively small spatial area. The highest NO₂ concentrations are centred around the Neath Road / Maliphant Street junction but, to the north of this area, a further cluster of isopleths are evident covering much of the northern area of the Hafod. This further area is within 200 metres of the highest concentrations but is at concentrations approximately half of the values seen at the centre of Hafod. To the south of this central high cluster is another area extending south from approximately Earl Street, eastwards across the Morfa Road light industrial complex out over the River Tawe towards Foxhole Road. This area again indicates levels of NO₂ approximately half of those seen in the central area of Hafod.

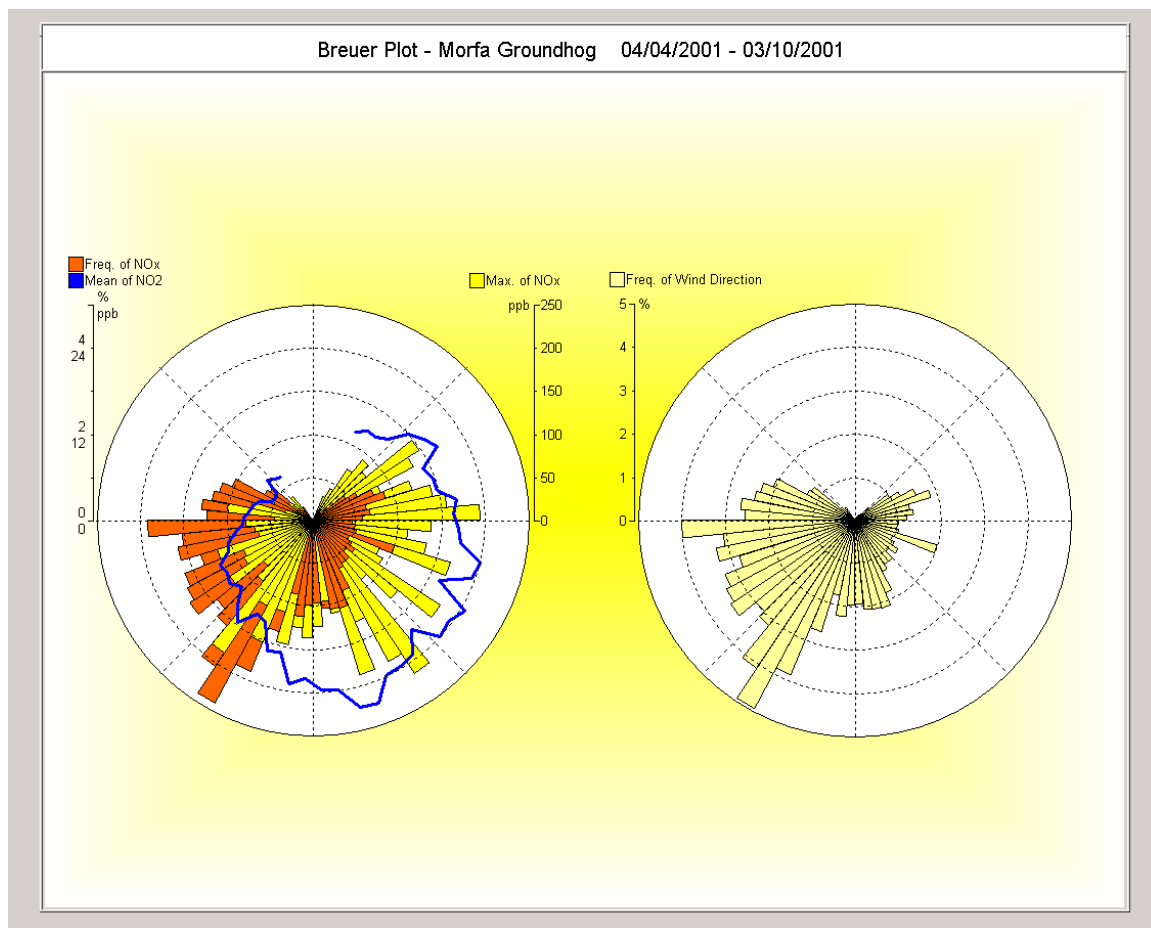

Breuer Classification Plot 2 – Morfa Groundhog Summer Time Period –April – September 2001

Breuer Classification plot 2 above indicates that for the summertime period the frequency of NO_x loadings at the Morfa Groundhog mirrored the frequency of wind direction as would be expected. Significant maximum NO_x inputs into the area are from mainly an easterly direction with some being evident from the south-west. Due to the location of the Morfa Groundhog, these easterly maximum NO_x inputs can be attributed to emissions from the road infrastructure to the lower valley area in general.

Isopleth Plot 5 indicates NO₂ concentrations for the winter time period October 2001 – April 2002 to the majority of the lower valley area.

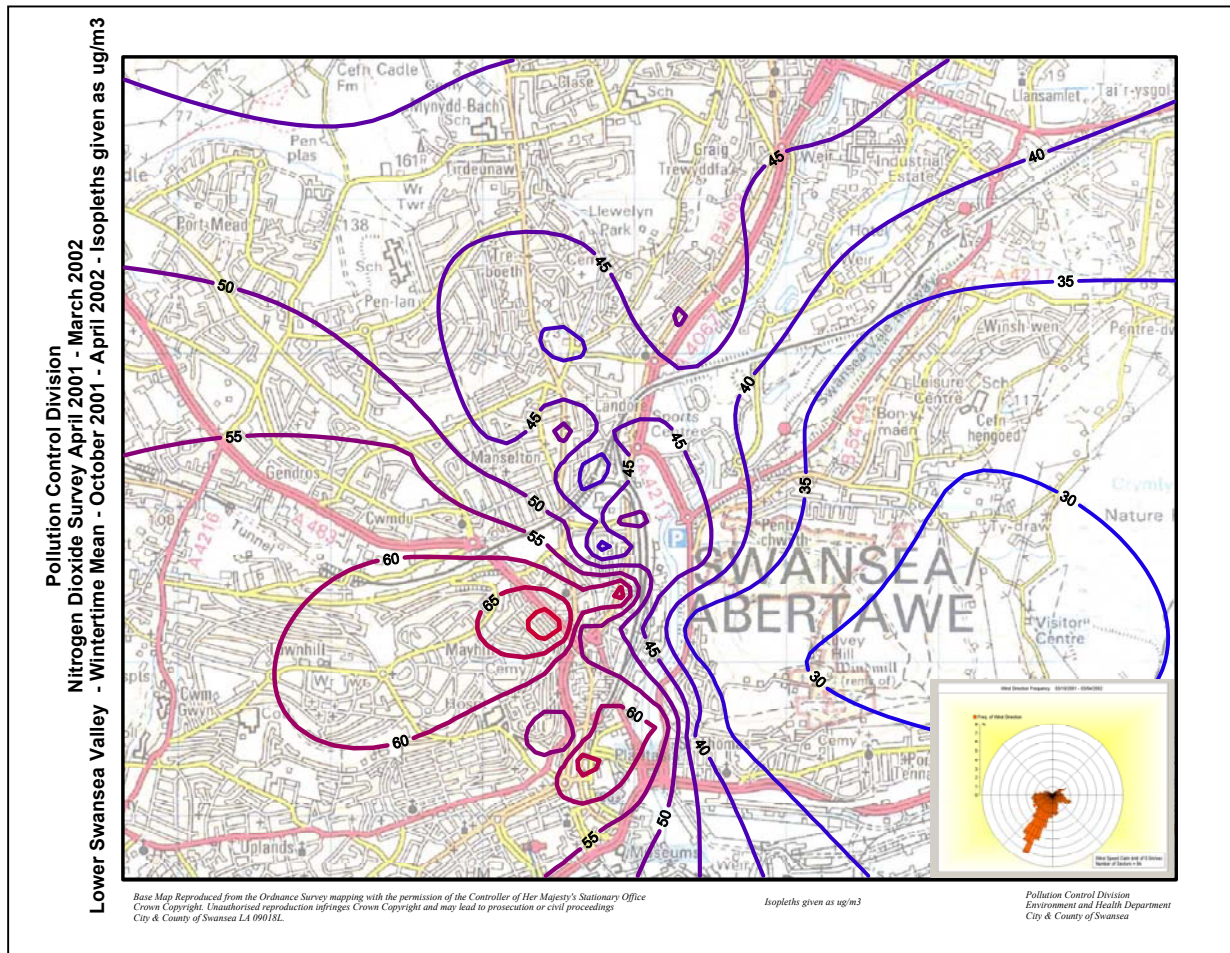

Isoleth Plot 5 - Wintertime Mean NO₂ concentrations – Lower Valley Area

Again, the same pattern in isopleth concentrations can be seen to the same general areas as shown in the study mean and summertime period. However, during this winter period, much as would be expected, the levels of NO₂ are significantly elevated. This can be seen in the mean NO₂ isopleths concentrations around the Quay Parade bridges extending towards the City Centre/Parc Tawe and St. Thomas regions are now in the range 50-60µg/m³.

For clarity and in order to focus in on the problem area, Isoleth Plot 6 has been “focused” within the Hafod area to provide spatial averaging robustness as this is where the majority of sample points were located and can be seen below.

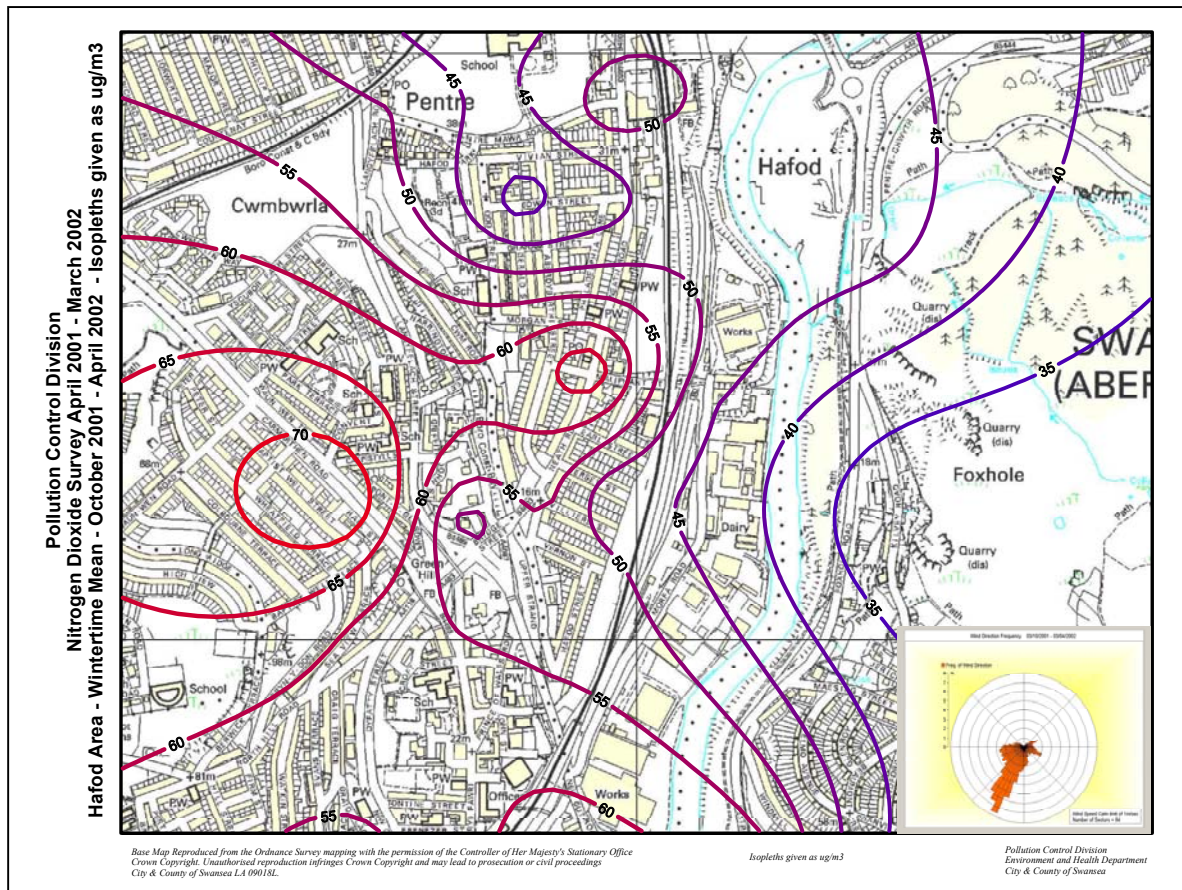

Isopleth Plot 6 – Wintertime Mean October 2001 – April 2002 – Hafod Area

NO₂ isopleths around the Dyfatty interchange extending up Carmarthen Road towards Cwmbwrla roundabout and down into the Hafod area, are in the range 55-70 $\mu\text{g}/\text{m}^3$. Concentrations of NO₂ within the Hafod are again centred on the Neath Road / Maliphant Street junction. There is an area to the northern extent of the Hafod that is, again approximately 15 $\mu\text{g}/\text{m}^3$ lower than the central area. The distinct isopleths of lower NO₂ concentrations to the southern area of the Hafod seen during the summertime are no longer evident.

The highest levels of NO₂ concentrations are now to be found in an area extending northwards up Carmarthen Road from the Greenhill/Dyfatty interchange towards Cwmbwrla roundabout.

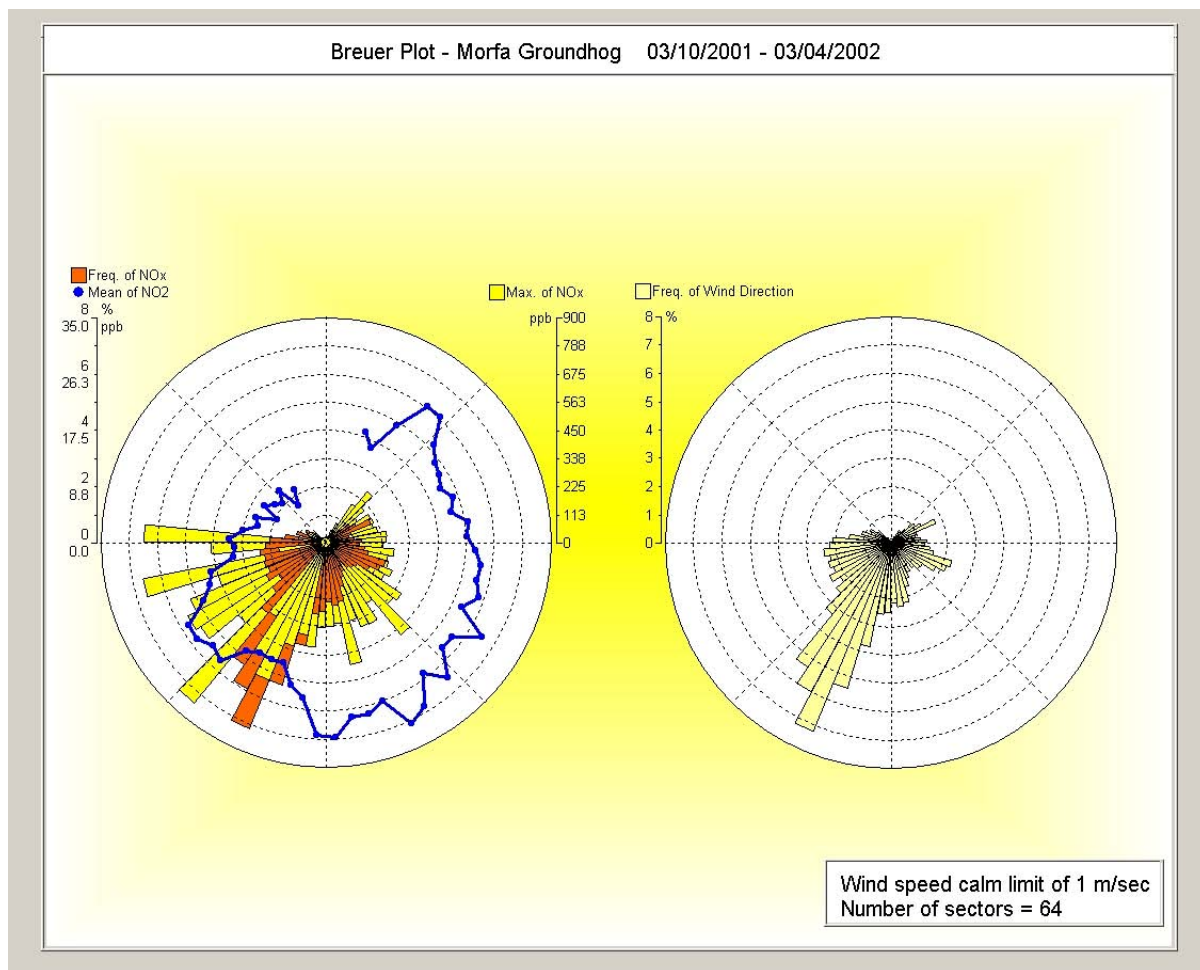

Breuer Plot 3 - Morfa Groundhog - Winter Period October 2001 - April 2002

Breuer plot 3 shows the result of the Breuer classification analysis carried out for the winter period October 2001 – April 2002. Significant NO_x inputs are shown to the south-west quadrant which again is indicative of traffic movements in the lower valley area.

From examination of the above isopleth plots it can be seen that whilst the Hafod Post Office Site (site 27 in weekly survey) returns the highest NO_2 annual mean of all sites, the problem area extends out of the Hafod itself, into the Greenhill/Dyfatty areas, down into the city centre and across to the eastside of Swansea around the Quay Parade bridges intersection. As would be expected, this mirrors the road network of the lower valley area.

2.2 Census Data

The Hafod AQMA either contains, or is boarded by, 7 local election wards. Again, it is accepted that some of these wards fringe onto the AQMA area and are not contained wholly within the AQMA, but it is probable that journey patterns may enter, or pass through the AQMA.

All data quoted from the Census 2001 is Crown Copyright 2003. The first data examined from the 2001 Census was the transport modes to work. Chart 1 illustrates the recorded modes of transport.

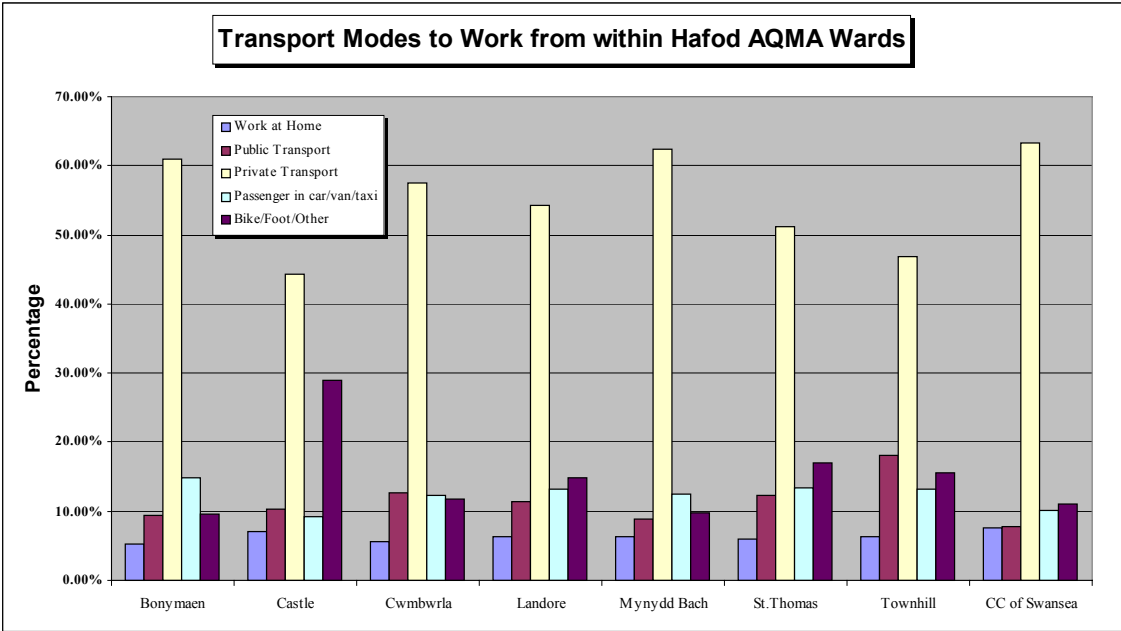

Chart 1 – Transport modes to work from within the Hafod AQMA

The dominant mode of transport is, as one would expect, private transport with an average of 53.97% of the population within the wards travelling to/from work by this method. This compares with an average of 63.37% taking into account the population as a whole of the City and County of Swansea. Interestingly, the Castle ward indicates the lowest percentage of travel to work by this method. This can, however, probably be explained by the proximity of the Castle ward to

the city centre itself when one also looks at the population who either walk or cycle to work from within the Castle ward.

An average of 11.86% of the population of these wards travels to work by public transport which is higher than the average of 7.83% for the whole of the City and County of Swansea.

It would appear from the Census data that a large proportion of the vehicle journeys to work are single occupancy journeys, as the overall percentage of travel modes to work as a passenger from within/to the above wards is 12.69%. This however compares favourably against a figure of 10.15% for the whole of the City and County of Swansea.

In order to try and fully understand these patterns, an understanding of the socio-economic makeup of these wards must be made. To the main the wards comprise of comparatively low value terraced, back to back housing with a high percentage of households renting accommodation from the authority in the Mynydd Bach (19.71%), Townhill (53.19%) and Bonymaen (26.65%) wards. Unemployment within some of these wards is high with Townhill (16.77%), Castle (9.49%), St.Thomas (8.43%), Bonymaen (8.42%) and Landore (8.03%) occupying 5 out of the top 6 wards suffering from unemployment. Again, an assumption can be made that disposable income within many of these wards is likely to be low. Those that possess vehicles are unlikely to replace them with modern vehicles with the latest engine management and abatement techniques. As a consequence, the vehicles to be found within these wards probably comprise of vehicles of pre Euro era, with little or no abatement techniques fitted, be of high mileage, and thus may be suffering from high wear and tear. The implications from cold starts and the reverse hot soaks have not been

quantified as yet, but it is highly probable that some of the more grossly polluting vehicles may emanate from either within, or close to the AQMA.

Chart 2 below illustrates the number of households within these wards that are with/without car(s) or van(s).

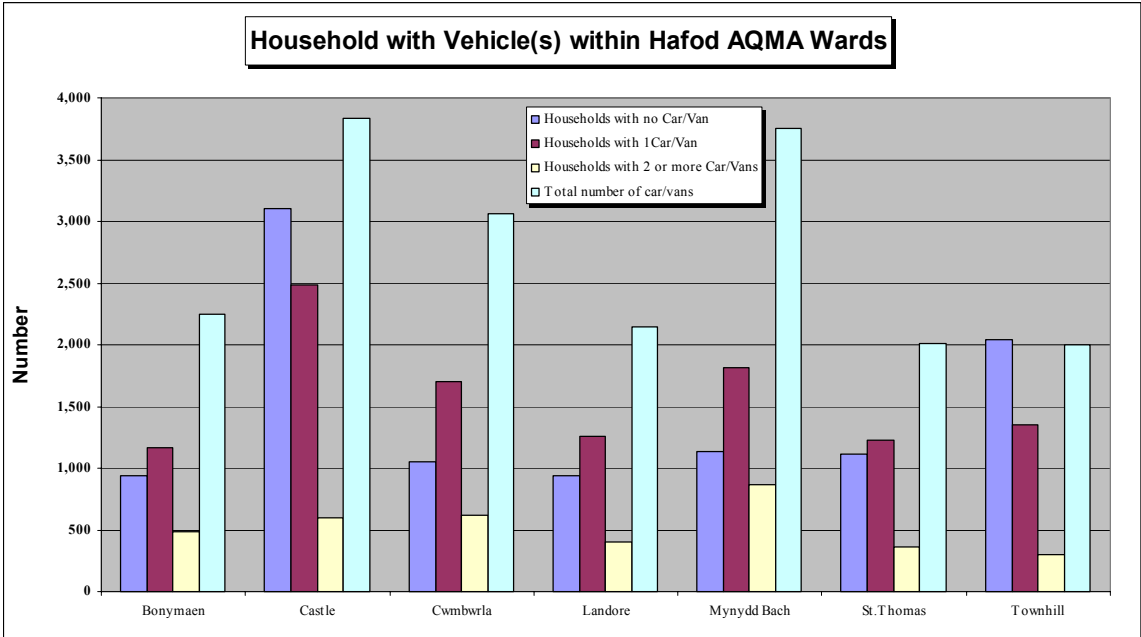

Chart 2 – Households with/without vehicle(s) within Hafod AQMA

Castle ward, despite the high percentage of households that walk or cycle to work (see chart 1) now shows two interesting results: the first is that it is shown to have the highest number of households without a car/van which would tie in with the observations from chart 1, but secondly, that it also has the highest total number of cars/vans of the wards highlighted here.

2.3 Topography and Road Network of the Lower Valley Area through the Hafod District

The primary route through the Hafod district is a section of the Neath Road B4603. The B4603 was, at one stage the primary route down the whole of the lower Swansea Valley. The B4603 extends from within Morrision, through the

districts of Plasmarl and Landore. Both of these areas have dwellings that front onto the B4603 which comprise primarily of a similar housing stock to that seen within the Hafod ie. terraced housing fronting directly onto the carriageway. However, both these districts have seen the construction of the A4607, effectively creating a bypass of the B4603. Both the B4603 and the A4607 follow the terrain along the valley and are separated within the Morriston/Plasmarl districts by approximately 75metres. The A4607 through these areas was constructed along the line of the former Swansea canal. From Morriston northwards further improvements have been made to the A4607 which have seen the construction of an underpass at Morriston Clase Road roundabout, and dual carriageway up to its junction with the M4 at Ynysforgan.



Map 3 –Topography and Road Network of the Lower Valley Area

At Normandy roundabout, at the start of the Hafod district, the B4603 and the A4607 effectively meet. The A4607 then becomes/diverts onto the A4217 in an

easterly direction towards the River Tawe and crosses the Tawe at White Rock Bridge. The A4217 then merges with itself (Pentrechwyth bypass) and follows the terrain along the eastern flank of the lower valley along the A4217 Foxhole Road and Pentreguineau Road towards the Quay Parade bridges. Congestion is a problem at Quay parade bridges which sees the A4217 merge with the main A483 coastal route.

The problems experienced within the Hafod district are as a direct result of drivers making the conscious decision to suffer delays on the B4603 through the Hafod, rather than suffer delays on the A4217 at Quay Parade bridges. In many cases the destination of traffic on both routes is the same - the City Centre.

This situation is obviously the reverse with motorists travelling in the opposite direction. Drivers travelling northwards from say the City Centre up the valley towards the Enterprize Zone and beyond from the western districts of Swansea, are reluctant to use the eastern A4217 through Foxhole because this entails suffering delays along the A4067 and Quay Parade bridges. The route taken in these instances is thought to be the A4118 towards Dyfatty junction, picking up the B4603 through the Hafod towards Normandy Roundabout.

Some of this driver behaviour can probably be put down to drivers becoming accustomed over the many years of using the original B4603 to having always passed through this area to reach their intended destination and old habits die hard. This view has been reinforced by the delays experienced at Quay Parade bridges. An Origin Destination survey has been undertaken and a summary is detailed within Appendix 1.

The congestion on the B4603 along Neath Road through the Hafod is compounded by traffic calming measures undertaken over the past 10 years or

so. The section of Neath Road from the Normandy Road roundabout has seen the provision of road narrowing, speed humps and mini roundabouts in response to local residents' concerns. However, the major factor in the congestion along Neath Road is thought to be the set of traffic lights on the junction of Neath Road and Maliphant Street/Monger Street.

Maliphant and Monger Streets are minor roads leading mainly to residential areas. Maliphant Street does however, provide access and a "rat run" to Morfa Road and ultimately with New Cut Road in the Strand leading to Quay Parade bridges.

The traffic signal loop detectors on Maliphant Street and Monger Street "trip" the lights on Neath Road to show red when only one or two vehicles are waiting to exit these street(s). The 30 – 60 seconds that it takes for the phase to revert to green along Neath Road results in considerable queues being formed in both directions along Neath Road. The sensors within Maliphant Street and Monger Street can trip the signals with only one vehicle being detected by the sensor array. The system has also reverted the phase to red on Neath Road when no vehicles are within these side streets.

One of the primary action points that are being actively considered is the complete removal of this set of traffic lights. It is recognised and is detailed later within this document (see Hafod Integrated Transport Study 3.3) of the need for a pedestrian crossing at this point of Neath Road. The impact that a pedestrian controlled set of traffic lights may have on the overall traffic flow will need close and clear assessment. For example, the pedestrian controlled crossing may be fitted with a timing device to prevent "over-use". The effect of this action can then be measured and quantified both by the air quality, and traffic monitoring systems in place along Neath Road.

The above option has been put forward as a priority of any Action Plan. It is also included for consideration as part of the Hafod Integrated Transport study which is discussed in greater detail in 3.3. The Hafod Integrated Transport Study has considered this and a whole host of additional measures to tackle the congestion along this section of Neath Road.

Areas of illegal parking along Neath Road greatly hinder existing traffic flow primarily through the lower sections of Neath Road. Vehicles are often seen to park half on, half off the pavement, sometimes on either side of the carriageway. This has the effect of considerably narrowing the carriageway, forcing vehicles to stop in one direction. This adds to the congestion problems. Parking restrictions are clearly painted on the carriageway but this appears to have little effect by way of a deterrent. This is clearly evident with the illegal parking that is seen within the dedicated bus stops along the route.

As has been mentioned, congestion is a problem throughout the lower section of the Swansea Valley. Whilst the Action Plan's focus will inevitably be within the Hafod district, regard must, and will be made, to the effects that any action(s) taken will have on the Quay Parade bridges area and the Dyfatty lights/Carmarthen Road junctions.

The situation regarding Quay Parade bridges is seen as critical to the Action Plans success, and the current situation is outlined below in 4.9

3 Existing Strategies and Consultation

3.1 The City and County of Swansea Local Transport Plan (LTP) 2000 – 2005

The LTP is based on the Authority's Transportation Strategy which itself was developed through consultation and using the results of four earlier studies on transportation issues in Swansea.

The authorities transport objectives are:

- To promote public awareness of transport issues,
- To make the best use of existing transport facilities,
- To improve accessibility for all,
- To improve safety,
- To assist economic growth and development,
- To reduce the adverse environmental impact of transport,
- To encourage a more environmentally sustainable transport system,
- To encourage healthier forms of transport,
- To reduce reliance on the private car by promoting attractive alternatives, and by careful location of new developments.

In preparing the Transportation Strategy extensive consultation was undertaken both inside and external to the authority. Four strands of consultation were used in the development of the Transportation Strategy:

- A Corporate Working Group,

- A Transportation Forum – consisting of officers, councillors, transport operators and transport users,
- A Survey of transport attitudes by way of household surveys,
- Extensive consultation using the authority’s free newspaper, Community News.

Four Internal sub groups were established as part of the Corporate Working Group, focusing on Road Traffic Reduction, Land Use and Development, Public Transport and Accessibility. These internal sub groups were assisted by departments traditionally overlooked in transportation consultation but with a vital impact on travel needs such as Education, Social Services and Leisure.

In recognition that Swansea could not achieve integrated transport in isolation as current trends in work and leisure journey patterns cross local authority boundaries, close working was established with these authorities by way of the South West Wales Integrated Transport Consortium (SWITCH) forum. This forum ensured that policies and plans between the participating authorities were coordinated.

Following member input on the Transportation Strategy this work was then fed into the Transport Corporate Action Team for formulation of the draft LTP. Additional input was gathered by way of Youth Groups, Citizens Panel, Local Employees and other key consultees. A series of workshops were arranged for consultees to discuss Swansea’s transport problems and to discuss ways to make any improvements. The main themes that emerged were:

- **Public Transport interchanges** – a particular need was seen to improve High Street Station and the Quadrant Bus Station in terms of access, comfort / safety and information for passengers.

- **Bus Services** – need to be more reliable, more frequent and provide greater coverage cross-city. Accessibility was also highlighted as was the level of service information disseminated. Fares were considered as being too high with fare concessions only for the elderly and not determined by need.
- **Park and Ride** – there was widespread support for high quality, frequent services to the city centre.
- **Corporate co-ordination** – this was considered important in planning and delivering council services.
- **Travel Awareness campaign** – the need was recognised for positive and pro-active alternatives to the car highlighting the problems that excessive car journeys create.
- **Freight distribution** – it was thought that the authority should bring together all those parties involved and act as a catalyst in the process of promoting more sustainable distribution.
- **Safety problems** – strong concerns were expressed about actual and perceived problems associated with the use of public transport. In addition, concerns were highlighted with actual and perceived road safety issues associated with walking, cycling as well as driving.
- **Parking Enforcement** – this was considered to be inadequate.
- **The School Run** – there was widespread support for the efforts to reduce the associated problems with awareness of the alternative choices available. The development of safe routes to school was supported.
- **Traffic calming** – the principle was supported but a more consistent and bus and cycle friendly design was considered necessary. Whilst recognising the above, it is felt that the major problem experienced along the Neath Road corridor and in the wider Hafod area with nitrogen

dioxide levels is directly caused by the traffic calming measures undertaken.

- **Travel Plans**– there was support for the development of Travel Plans for large organisations. These were seen to have a major role in reducing peak hour congestion and the provision of alternative travel choices. The authority was urged to lead by example
- **Cycling**– the provision of improved facilities to encourage this form of transport was encouraged.
- **Walking**– this was considered important for those short journeys. The needs of pedestrians were considered worthy of higher priority.

Following the inclusion of the above measures within the draft LTP further workshops were organised where the key consultees were briefed on the formulation of the LTP. As part of these workshops, consultees were requested to discuss and consider:

- 1) The priorities for the LTP
- 2) How to improve access to the city centre.

The priorities identified for the LTP by “Diamond Ranking” were then split into two diamonds each consisting of 9 measures: the first detailing those measures considered to be the highest priority and the second the next 9 priority measures. The measures given the highest priority were:

- Improve urban bus services,
- Improve facilities for mobility impaired,
- Develop a road maintenance strategy,
- Develop Park & Ride sites,

- Complete gaps in the strategic network,
- Improve the quality of bus and rail stations,
- Implement road safety measures,
- Improve city centre parking,
- Develop company Travel Plans.

Measures given the next highest priority were:

- Develop School Travel Plans,
- Improve rail services,
- Improve rural bus services,
- Improve pedestrian facilities,
- Improve facilities for HGVs,
- Improve access to health and leisure facilities,
- Implement traffic calming,
- Improve facilities for cycling,
- Develop Traffic Management Plan for the Gower.

From the series of workshops there was a high degree of consensus into how to improve access into the city centre. Common themes included:

- Improve pedestrian links to the foreshore and Maritime areas
- Strengthened pedestrianised area
- Circular bus service connecting major attractions
- Improvements to maintenance
- Improved parking for disabled people's vehicles
- Park and Ride on all radial routes into the city centre
- Travel Plans for city centre organisations to discourage car travel

- Increased priority to pedestrians and cyclists in the city centre

3.2 Land Use Development and the LTP

The links between the land use development and travel patterns are important. The pattern of new development, redevelopment and land use changes has had a major impact on transport patterns. In general, the cumulative effect of land use trends has been to encourage or even require people to make longer journeys. To the main these journeys have been made by car because recent developments are difficult or impossible to reach by other methods.

Current advice and planning policy emphasise the need for planning policies to integrate transport, land use and environmental considerations. In particular they stress the contribution of planning policies, and the siting and design of new development, to achieve the following transport objectives:

- Reducing the level or the rate of growth of road traffic,
- Encouraging the use of public transport, cycling and walking,
- Reduce the reliance of the private car.

The Unitary Development Plan (UDP) is still in its draft form (currently thought to be approaching final draft form) and it is envisaged it will carry forward policies formulated within the existing Development Plan (Structure Plan and Local Plans). These policies bring forward a number of key transport factors relevant to land use planning namely:

- Encouraging mixed use development,

- Allocating under utilised urban land for development instead of possibly more distant green field sites,
- Safeguarding and strengthening the established district centres and the city centre which are already well served by public transport,
- Ensuring that new development makes full allowance for walking, cycling and public transport, together with catering for people with special needs.

These key factors are followed through into policy within the UDP by way of the following action initiatives:

- Passenger rail improvements,
- Improved bus and rail stations,
- Improvements to bus corridors,
- Environmental improvements through the implementation of a limited number of road schemes,
- Continued development of Park and Ride provision,
- Support for schemes to enhance the commercial viability of the Port of Swansea.

The UDP will seek to ensure an integrated approach to the delivery of a high standard of accessibility with, to, and from the authority's area. In order to achieve this, the UDP deals with a number of factors:

- Ensuring that development is permitted at accessible locations,
- Promotion of attractive alternatives to the private car,
- Ensuring safety and a reduction in environmental impacts,
- Ensuring efficient use of the existing road network,

- Promotion of improvements to the transport network to meet the needs of existing and future businesses,
- Ensuring good access for all communities to work, service and leisure opportunities.

The authority has agreed the following development principles which will help to define the scale and location of future development:

- To continue with existing redevelopment strategy for the Lower Swansea valley and the city centre, with the consolidation of surrounding settlements,
- To meet additional land use needs up to 2016 by:
 - Encouraging development and regeneration of “brown-field” sites, underused and vacant land/property in preference to the development of Greenfield sites,
 - Supporting and improving existing settlements and encouraging a greater mix of compatible land uses within the developments,
 - Capitalising on Swansea’s waterfront environment to meet economic needs, both in terms of use of the port, sea, rail and road facilities to encourage sustainable distribution as well as the developing needs of tourism,
 - Encouraging the provision of new housing in a phased manner close to or with good access to major employment and/or community facilities, with good access to public transport,
 - To protect any environmentally and ecologically sensitive areas from development,
 - To ensure that land use policies are compatible with the other aspirations of the authority.

3.3 The Hafod Integrated Transport Study

Mouchel Parkman were commissioned to carry out a traffic management study within the Hafod area. Part one of the study involved a review of the previous Hafod Integrated Transport Study in 2001 with the City Centre Transport and Development Study, 2003. Part two involved developing traffic management measures to alleviate congestion in the primarily residential area of Hafod along with generally improving the conditions for pedestrians and cyclists. Mouchel Parkman were requested to specifically investigate the feasibility of a bus gate option along Neath Road. Heavy emphasis was placed on consulting and involving the local community during the whole process leading up to development of the final proposals.

The previous Hafod Integrated Transport Study 2001 recommended either a Hafod bypass or a new River Tawe road bridge. The City Centre Transport and Development Study, 2003 also favoured these two options. Both studies considered that a 10-20% shift to non-car modes could be achieved through promotion of park and ride, park and walk, regular bus service improvements and various city centre parking policies. However, even this would not now be sufficient to offset the predicted traffic growth for this corridor even if funding and sufficient land could be made available. Studies have forecast an increase of between 16 – 30% by 2006 and between 50-60% over 2001 levels in the corridor (including the A4217 Pentreguinea Road and the B4489 Llangyfelach Road.)

Recent major developments in the area, notably the Morfa Retail Park and Sports Stadium will have a major impact, particularly during the evening periods. The Hafod Integrated Transport Study in 2001 forecast that these

developments would generate an additional 1900 trips during the evening peak hour during 2006, of which 14% would be via the B4603 Neath Road, Hafod. This could potentially increase the two-way traffic on Neath Road by about 18% during the evening peak hour.

Whilst it would be neither practical or desirable due to the knock on effects to the surrounding area to close the B4603 Neath Road through the Hafod, measures to mitigate the forecast growth need to be taken. This approach has resulted in the development of traffic management options to discourage extraneous traffic. Built into this approach was a desire to generally enhance the corridor through any physical works carried out. It is anticipated that any adopted measures will remedy the severance thought to exist between the community either side of the corridor, as well as the poor environment for pedestrians and cyclists.

Extensive consultation has been undertaken with the various interested groups and also, representatives of the local community itself. Additional details on the consultation process can be found in section 3.3.2 below.

3.3.1 Traffic Management Options Appraisal

The traffic management options considered were:

(a) Additional traffic management along Neath Road including

- More stringent traffic calming
- Enforcement of a HGV ban
- Cycle lanes and facilities
- Speed camera enforcement along Neath Road of speed limit

Conclusion: The outcome of the above options were in part determined by the traffic calming measures that have already been undertaken during the last decade. These measures have not dissuaded through-traffic to a sufficient degree to facilitate a satisfactory outcome. For the purposes of this study, traffic management measures were an integral part of the projects terms of reference. However, in isolation, these traffic calming measures would not address the issue of reducing through-traffic, therefore, other strategic measures need to be considered.

(b) Bus gate on Neath Road accompanied by

- Traffic management measures on Pentremawr Road and Cwm Level Road (aimed at preventing use of this “rat run”)
- Traffic management measures at Quay Parade Bridges to accommodate the traffic diverted from Neath Road
- Peak hour operation of bus gate only
- Operation in dominant traffic direction only
- Linking the operation of the bus gate to real-time air quality monitoring along Neath Road and variable Message Signs
- Location of the Bus Gate south of the junction of Pentremawr Road
- Allowing access for high occupancy vehicles

Conclusion: Whilst a bus gate would bring a significant and dramatic reduction in traffic (97% - HITS Study 2000), there would be a major increase of 37% on the A4127 Pentrechwyth Road. The HITS 2000 suggested that with re-arrangement of lane layout and signal timings at the Quay Parade bridges that the capacity at this major junction could be increased by 20%. Yet, even with

these capacity improvements, by diverting the traffic from Neath Road to the Quay Parade bridges congestion would be unavoidable at the Quay Parade bridges. Follow up studies have revised the predicted capacity increase at the Quay Parade bridges to 3% following any improvements to the lane layout and signal timings. These latest findings now indicate that congestion at Quay Parade bridges following diversion of Neath Road bound traffic would be considerable.

Other disadvantages such as enforcement have been identified and a large number of exemptions would be required i.e. emergency services, local residents (estimated population living within the Hafod AQMA as a whole is 11,615), delivery vehicles, taxis etc. The cost of fitting transponders to every exempt vehicle and general maintenance would be of concern.

This option has not been taken forward due to a combination of the impact that any diverted traffic would exert to the overall road network as well as the practicalities of enforcement.

(c) Using Llangyfelach Road/Pentremawr Road as a bypass to Neath Road including

- Use as a bypass for either southbound or northbound vehicles only
- Use as a bypass at peak periods only (outside school hours)

Conclusion: Whilst this option would route traffic from Neath Road onto Llangyfelach Road, implementation of this scheme would require “improvements” at the junction of Pentremawr Road and Llangyfelach Road i.e. a right hand signal controlled turn from Llangyfelach Road into Pentremawr Road. This layout was introduced some 5-10 years ago as part of previous plans to address congestion in the area. This move had a dramatic and severe impact

upon the lower sections of Llangyfelach Road. Traffic quickly formed queues at peak times in a southward direction along Llangyfelach Road towards its junction with New Cut Road and the Dyfatty lights interchanged due to the absence of a dedicated right hand turn lane at this junction with Pentremawr Road. After approximately 6 months, this traffic-controlled junction was removed. Ownership of the land required to allow construction of a right hand turn lane at this junction is in dispute and ownership is likely to remain an issue for the foreseeable future.

Even if the above issues were to be resolved, other major disadvantages have been identified namely:

- Heavy traffic flows would be experienced along Pentremawr Road and outside Pentrehafod Comprehensive School
- No significant discouragement to through traffic and nothing to limit further increases
- Exceedence of the air quality objective in 2005 for nitrogen dioxide has already been predicted for the southern sections of Llangyfelach Road close to its junction at New Cut Road/Dyfatty interchange. Increasing the flows along the lower section of Llangyfelach Road will compromise compliance at these locals further.

This option has not therefore, been taken any further.

(d) Improve Pentremawr Road and Ysguborfach Street to provide orbital route from Neath Road to Carmarthen Road

Conclusion: This option was proposed to improve the east-west traffic flow and to possibly divert some east-west traffic from Neath Road and Dyfatty junction.

Studies of movements between Carmarthen Road and Bridge Street found significant flows over a 10-hour period of approximately 5000 either exiting or entering by this direction. Unfortunately, the vehicles undertaking these movements were not tracked any further so it is unclear as the proportion that either originated from or departed to/via Neath Road. It is also not clear how much traffic flow could be diverted from Dyfatty junction by fully opening up the junction of Ysguborfach Street/Carmarthen Road (left turn into Ysguborfach Street from Carmarthen Road only at present). It is also not clear what impact upon Carmarthen Road itself this move would have and how it could be achieved.

In view of the lack of stakeholder support for routing traffic onto Pentremawr Road and the conclusions of option c it has been decided at this stage not to progress further with this option at this time. This does not preclude this option from being investigated further as part of a wider scheme to improve traffic flows.

(e) Connect Cwm Terrace with New Cut Road to provide a slip road for southbound Neath Road traffic

Conclusion: This proposal originated from the consultation workshops (See 3.3.3 below) and offered two benefits.

- Firstly it may be possible to reduce congestion southbound along Neath Road caused by the New Cut Road/Bridge Street and Dyfatty interchanges as a significant amount of traffic turns left down New Cut Road at this location. By opening up a link direct to New Cut Road from Neath Road/Cwm Terrace, traffic intending to turn left could do so earlier, reducing queuing northbound up Neath Road.

- The second benefit was that it could enable the provision of a southbound bus lane at the junction.

Following investigation of this proposal, whilst it was found that the option was technically possible, there were disadvantages. Firstly, it was felt that this option may make Neath Road more attractive as a through-route for southbound traffic (negating the need to negotiate the Quay Parade Bridges) and creating a rat run on Cwm Road for southbound traffic from Llangyfelach Road. Secondly, there would be environmental impacts from the increased traffic along Cwm Terrace both in terms of increased noise and possible increased pollution loadings. It was thought that the remodelling of the Dyfatty and New Cut Road junctions was outside of the scope of the brief.

(f) Bus lanes at junction of New Cut Road and Neath Road/Bridge Street

The South-West Wales Integrated Transport Consortium (SWITCH) study of 2000 mentioned the possibility of introducing bus lanes at the approaches to the New Cut Road junctions. Three bus lane options were identified:

- Southbound bus lane on Neath Road from Cwm Terrace to New Cut Road;
- Northbound bus lane from New Cut Road to junction with Cwm Terrace;
- Northbound bus lane (as previous) with a traffic control point at the signals at Cwm Terrace junction.

Conclusion:

The southbound bus lane would require implementation of option (e) above to remove left turning traffic. It would also involve reducing northbound traffic to one lane causing delays at the Cwm Terrace junction with right turning vehicles.

Any benefits of this option would also depend on what arrangements could be made for buses continuing into High Street and Dyfatty. It was thought that the remodelling of the Dyfatty and New Cut Road junctions was outside of the scope of the brief.

With regard to the northbound bus lane from New Cut to Cwm Terrace, whilst there is little queuing northbound the discouragement to through traffic due to increased delay at Cwm Terrace due to right-turning vehicles. A northbound bus lane would preclude a southbound bus lane. This option would need to be considered as part of any works undertaken at the Dyfatty interchange and as in option (f) it was thought that the remodelling of the Dyfatty and New Cut Road junctions was outside of the scope of the brief.

(g) Traffic control point on Neath Road to discourage south-bound traffic including

- Advance notice to motorists via Variable Message Signs

Conclusion: This proposal was first put forward by the SWITCH consortium and suggested a traffic control point on Neath Road at its junction with Bowen Street, giving southbound buses priority. Two disadvantages of this proposal are:

- The effects of queuing traffic on air quality (Morfa Terrace)
- The location of the control point might encourage some southbound traffic to divert via Pentremawr Road and Llangyfelach Road.

This idea was developed further to locate the control point at the entrance/exit of the new Hafod Express Bus Route to the Landore Park and Ride site. This

location would utilise the traffic signal controlled junction for the express bus route. By holding traffic at this location, some of the queuing taking place at the Maliphant Street and New Cut Road/Dyfatty junctions could be shifted northwards towards Normandy roundabout. However, from an air quality perspective, the upper sections of Neath Road may then also fail the nitrogen dioxide objective in 2005 as traffic would be held up to the Normandy Road roundabout (and possibly beyond) past Morfa Terrace which contains terraced housing fronting directly onto the carriageway. Discussions are ongoing to further modify this proposal by either allowing free flow of traffic except when the lights are activated by a Park and Ride Bus service or by introducing a detection loop outside Morfa Terrace to detect congestion and re-phase the traffic control point.

It is worth pointing out that as part of the Landore Park and Ride Express Bus route, a traffic signal controlled junction has been formed in the area of the Bowen Street/Neath Road junction (as per SWITCH proposal). However, this will only activate every 12 minutes or so to allow the park and ride service access from the express bus road back onto Neath Road (see 4.1.1)

(h) Northbound traffic control point including

- Advance notice to motorists via Variable Message Signs

Two sub-options were developed:

- Traffic control point at traffic signals at Cwm Terrace junction
- Traffic control point at the Dyfatty intersection

Conclusion: Both of these options could potentially increase congestion back through Dyfatty Street and High Street and have knock on effects towards the

city centre. Also, delaying traffic at Cwm Terrace could encourage traffic to divert via Llangyfelach Street/Llangyfelach Road and Pentremawr Road. This is particularly relevant to northbound traffic trying to reach the new Morfa Retail Park and Sports Stadium.

Whilst the Mouchel Parkman study concluded that to link the control point to air quality measurements could limit its effectiveness as the occurrence would be unpredictable, the air quality models under development will be capable of predicting poor conditions up to 8-hours in advance of those conditions occurring. It is accepted that despite predicting air quality episodes and reacting to the prediction via variable messaging signs, the fact is that this may not permanently change peoples travel patterns.

3.3.2 Measures to be taken forward from the Options Appraisal process

Two options are to be taken forward:

- Traffic management measures on Neath Road, to improve safety, environment, and facilities for pedestrians, cyclists and bus users, and also to reduce the attractiveness of Neath Road as a through route.
- A traffic control point at the junction of Neath Road and the express bus route entrance of the Landore Park and Ride site to hold traffic out of the lower sections of Neath Road.

3.3.3 The Consultation Process

Public consultations were an important phase of the development of the final proposals outlined above. Consultations were carried out in three stages:

a) Preliminary Consultations

In addition to the input of officers from the Transportation Section, a preliminary meeting was held with the Hafod Community Partnership in January 2004. This meeting explained the scope of the transportation study within the Hafod area and to agree on a methodology for the local consultations.

b) First Round of Consultation Workshops

In late January 2004 an initial set of proposals including initial various strategic and traffic management options were taken to a first round of consultation workshops at the Odo Street Community Centre.

Participants were invited and chosen to represent key organisations with an interest in the Hafod proposals together with a selection of residents. The representatives were mostly street representatives from different parts of the Hafod area. Two sessions were conducted and a total of 33 people attended.

Several key themes emerged from these workshops, namely:

- Support for a Hafod bypass;
- Strong opposition to diverting Neath Road traffic via Pentremawr Road and Llangyfelach Road;

- Strong opposition to the location of a bus gate on Neath Road south of Pentremawr Road because of the impacts upon Pentremawr Road and enforcement issues;
- Suggestions of road improvements for a slip road to new Cut Road
- Landore Park & Ride site was not being adequately marketed;
- Possibilities of providing a rail link into the new Morfa Retail Park and sports stadium complex.

Regarding traffic management measures some key points emerged:

- General agreement regarding the removal of the existing speed cushions along Neath Road
- Strong support for traffic management measures along Neath Road including the introduction of a 20mph zone;
- Support for widening footways and improving pedestrian crossing facilities (severance of community)
- Requests for parking to be maintained along Neath Road, especially outside local shops along the lower sections of Neath Road;
- Concerns about lack of parking enforcement
- Lack of support to close Maliphant Street (through route to Morfa Road/New Cut Road/Quay Parade bridges)
- Measures to limit HGV's in the area
- Request for tree planting and landscaping to be undertaken.

c) Second Round of Consultation Workshops

The feedback from the first series of workshops was developed in more detail in preparation for the second round of consultation workshops. These proposals

focused on a southbound traffic control point at the junction of Neath Road and the express bus route exit from the Landore park and Ride site and the junction of Neath Road with new Cut Road.

Two alternative traffic management proposals were developed:

- Vertical deflection and visibility splays and junctions and crossings
- Elevated tables at junctions to reduce traffic speed and enable easier pedestrian movements(addressing the severance of the community from this corridor).

The second round of workshops were again held at the Odo Street Community centre and took place in early March 2004. The aim of these workshops was to consult a broader cross section of stakeholders and local residents. In total three workshops were attended by 24 people. The Hafod Neighbourhood Renewals Team invited approximately 30 street representatives and local residents – many representing the local ethnic community.

Stakeholders and local representatives were given the opportunity to choose between two design options, as well as fine tuning other proposals. The key points to emerge from the workshops were:

- Little support for speed cushions at junctions on Neath Road;
- Emergency services strongly objected to vertical deflection speed cushions along Neath Road as Neath Road is a main emergency route to Morriston Hospital;
- Removal of the traffic lights at the Neath Road/Maliphant Street/Monger Street junction generally supported;

- Removal of the mini-roundabouts along Neath Road (junctions of Neath Road with Aberdyberthi Street and Neath Road/Tawe Avenue) generally supported;
- Suggestion instigated by residents to make Maliphant Street one-way only eastbound instead of its closure;
- Approximately 50% of parking along Neath Road to be reserved for local residents;
- Residents welcomed the proposals for tree planting and landscaping but wanted additional consultation over type and location;
- Concerns expressed regarding long term maintenance of any landscaping undertaken

Other suggestions came out of the workshops to fine-tune the proposals namely;

- Locating a pelican crossing on the south side of Maliphant Street/Neath Road junction (this would replace the existing set of traffic lights at this junction. Excessive activation of the lights should be investigated and prevented as frequent activation may replace congestion hopefully removed by the removal of the traffic lights);
- Locating a bus stop northbound along Neath Road outside the Hafod Post Office;
- Providing bus shelters to all bus stops along Neath Road between the Cwm Terrace and Pentremawr junctions.
- Providing disabled parking on Neath Road outside the Hafod Post Office.

Suggestions emerged for consideration at a later stage including:

- Tree planting within the curtilage of residents front gardens along Neath Road

- Traffic management measures outside Pentrehafod Comprehensive School, Pentremawr Road to improve safety and access (see section 4.3 Safe Routes to Schools)
- Improvements to the junction of Pentremawr Road and Llangyfelach Road to improve pedestrian safety and reduce inevitable congestion at this junction.

Additional Consultation

In a further attempt to avoid criticism and to ensure that as much of the Hafod community had been consulted as fully as possible, the proposals were placed at a further five locations:

- Hafod Area Renewals office adjacent to the Hafod Post Office, Neath Road;
- Hafod Community Centre;
- Pentrehafod Comprehensive School;
- Brynhyfryd Library, Llangyfelach Street;
- Offices of the City and County of Swansea at its County hall and Guildhall sites.

The above locations were extensively advertised by means of posters in shop windows, at the local library and renewals office etc. In addition all pupils at Hafod Primary School were sent home with a poster.

The response to this additional wider consultation was low with only a further four persons submitting comments.

In conclusion, there was a high level of support for the proposals that were developed. Significant opposition to diverting traffic from Neath Road through Pentremawr Road and Llangyfelach Road was made. There was also a high

level of support for the traffic management proposals for Neath Road i.e. narrowing of the carriageway to reduce speed, widening of the footways, bus shelter improvements, designated residents parking, removal of existing traffic lights and mini-roundabouts etc.

The consultation process resulted in a number of changes to the detailed design proposals that are discussed below as 3.3.4

3.3.4 Detailed Traffic Management Proposals

3.3.4.1 Highway Improvements

The measures currently under development and consideration for Neath Road mainly focus on the section between Cwm Terrace and the junction of Bowen Street. Measures necessary along the section of Neath Road from Bowen Street to Normandy roundabout are encompassed with some minor modifications in stages 1 and 2 of the Landore Express Park & Ride bus route.

It is proposed to narrow the carriageway width to 5.5 metres between Cwm Terrace and Bowen Street. This will satisfy one of the design aims to increase space for pedestrians. This reduction in carriageway width will have the effect of:

- Allowing the widening of the existing footways;
- Allow the provision of designated on street parking and reduce the level of illegal parking;
- Reduce vehicle speeds.

North of the junction of Bowen Street it is proposed that in accordance with the Landore Park & Ride Express Bus route phase 1 proposals, that the carriageway width be 6 metres.

The proposed width of 5.5m is deemed to be the minimum acceptable allowing a maximum tolerance of 0.5m for the largest vehicles with a greater tolerance for smaller vehicles (Source DoT Design Bulletin 32 - second Edition, Residential Roads and Footpaths).

Implementation of a 5.5-metre carriageway will be appropriate despite the expected volume of traffic as:

- It is proposed over a section of Neath Road approximately 500m long;
- It is located on a Primarily residential area with terraced dwellings fronting directly onto the footway;
- Relatively small proportion of HGV's (<3.5%);
- Number of buses using the section will be reduced when the Landore Park and Ride Express bus route is complete. It is accepted that local service bus routes will continue to use this section of Neath Road. However, it is anticipated, subject to discussions with the bus operators, that non-local bus services serving the upper reaches of the Swansea Valley will use the express bus route that will by pass this section of Neath Road.

In order to permit vehicles to turn at the junctions with side roads, all junction radii will be increased to between 4.5 to 6 metres.

The mini-roundabouts located at the junctions of Neath Road with Aberdyberthi Street and at Tawe Avenue will be removed. As part of these works the current

one-way access into Aberdyberthi Street will be closed off. This will simplify traffic movements in close proximity to the Cwm Terrace junction.

Aberdyberthi Street residents will benefit, as these works will create a quiet cul-de-sac. Similarly, removal of the mini roundabout at the Tawe Avenue junction will have the effect of simplifying traffic flow, and smoothing traffic flow by giving priority to Neath Road traffic.

Discussions are ongoing as to the feasibility of removing the traffic lights controlling the junction of Cwm Terrace and Neath Road/Bridge. Removal of these signals may further enhance the traffic flow to the lower reaches of Neath Road but the nearby junction of Bridge Street, Llangyfelach Road and New Cut Road will still prove a barrier and may well mitigate any possible gains/improvements made.

As mentioned within section 2.4 above, the traffic lights at the junction of Neath Road with Maliphant Street/Monger Street are a major factor in the congestion experienced along this section of Neath Road. As such, they are to be removed. Maliphant Street is also to be made one way eastbound at this point to discourage westbound traffic using this access as a rat run. In recognition that this is a favoured crossing point of pedestrians, a Puffin crossing is to be established south of the existing junction. However, measures will be need to be taken regarding the frequency of operation permitted as it will not be desirable to replace one congestion point with another.

The drawback of the removal of the mini-roundabouts and traffic signals is that it is recognised that access from the side streets will be delayed but in terms of the overall improvement in conditions expected it is acceptable for these delays to be experienced.

3.3.4.2 Pedestrian Improvements

A minimum footway width of 2m has been provided within the scheme with greater widths at junctions etc. At the junctions of minor roads with Neath Road raised crossings will be provided. The crossings will be at the same height of the existing footway. Raised footway crossing points are also a feature of the works being undertaken as part of stage 1 Landore Express bus route.

Pedestrian movement across Neath Road will be enhanced by the provision of:

- Controlled pedestrian crossings at:
 - Cwm Terrace (existing traffic lights);
 - New junction at Bowen Street of the express bus route;
 - Maliphant Street/Monger Street;
 - Outside 1351 Neath Road;
- Informal crossing points with refuge islands;
- Informal crossing points highlighted with surface treatment.

All informal crossing points are to be located close to junctions. A possibility exists to create a new footway between Neath Road and the city centre at the New Cut Road junction avoiding the long detours currently being experienced to cross the New Cut Road/Bridge Street/Llangyfelach Road junction by foot. This may encourage a limited number of journeys into the city centre to be undertaken on foot.

3.3.4.3 Parking provision along Neath Road

As mentioned elsewhere, the level of illegal and uncontrolled parking is having an impact on traffic flow and thus air quality. Designated parking bays will be provided along Neath Road where they are most needed ie outside residences and close to the commercial heart of Neath Road. Bay widths will be between 1.80 and 2.50 metres dependent upon available carriageway. Parking discipline will be “encouraged” by provision of bollards and tree planting at the ends of the parking bays. Several dedicated disabled parking bays will also be provided along with a dedicated unloading bay for commercial vehicles.

The proposals increase the total availability of legal parking along Neath Road.

3.3.4.4 Bus Stop Provision

Following the extensive consultation process and discussions with the local operators it is proposed to increase the number of bus stops and provide shelters at six of the stops along Neath Road. The stops are to be located:

Northbound

- North of the Aberdyberthi Street junction
- Outside the Hafod Post Office
- Outside 103 Neath Road

Southbound

- Opposite Aberdyberthi Street
- South of the Hafod Inn (south of Maliphant Street junction)

- Outside Livermores' (Bowen Street junction)

The last locations on each of the above are to be undertaken as part of the first phase of the Landore Park and Ride Express bus route.

Request stops are also proposed along the whole length of Neath Road. The buses will stop on-carriageway and whilst this may cause hindrance to the traffic flow it will enable the buses to avoid blocked bus bays and assist in the easy rejoining of the buses into the stream of traffic. Opposite Aberdyberthi Street an existing bus priority southbound is currently not used. It is proposed to re-establish this priority as part of the redesigned layout of this area. If the traffic signals remain at this Cwm Terrace junction, they will be rephased to allow priority to buses.

3.3.4.5 Cycle Routes

A number of existing cycle routes pass through the area. The main existing routes are:

- National Cycle Route 43 – the Celtic Trail – east bank of the River Tawe
- Sign posted route between Eaton Road/Llangyfelach Road and the city centre via Cwm Road
- Cycle route on the west bank of the River Tawe from the Morfa development (Sports Stadium and Retail Park) to the northern end of the Morfa Road Industrial Estate.

The traffic management proposals for Neath Road are expected to make the area and Neath Road more cycle friendly. Cyclist safety is likely to increase along

Neath Road as cars will be hesitant to overtake due to the reduction in carriageway width. There is a recommendation that cyclists be permitted to use the section of the Landore Express Bus route that uses Neath Road (between the Pentremawr Road junction and Bowen Street junctions)

3.3.4.6 Gateway Treatments.

It is intended to install gateway features at the Neath Road north (Normandy roundabout) and at the Cwm Terrace junctions. This will emphasise the residential character of the area that the traffic is entering from either direction.

3.3.4.7 Traffic Control Point.

Proposals for a traffic control point have been mentioned within the Traffic Management Options Appraisal (3.3.1.g). It has been proposed to site this control point at the junction of the Landore Park & Ride site with Neath Road. Initially, Mouchel Parkman proposed a cycle time of 140 seconds in the am peak and 115 seconds in the pm peak that would allow three phases of green for southbound Neath Road traffic, but just one phase of green for the Park & Ride site. This cycle time would result in an amber/red phase lasting about 20-30 seconds followed by a green phase lasting 20-25 seconds. Northbound traffic would be halted once every cycle for about 16 seconds, to allow traffic from the Park & Ride site to exit (provision has to be made for access into and from the Landore Social Club off this link road). Having modelled the effects of these cycles it was found that significant queues would be formed equivalent to around 85-110 seconds per vehicle in the am and pm peaks respectively.

If the above were accepted, this would require modifications to the junction of Pentre Mawr Road and Neath Road to prevent long queues forming due to traffic turning right at this junction. It is proposed therefore to remove the existing mini-roundabout and make Neath Road the priority route with a dedicated right turn lane.

Discussions remain ongoing over the exact method of operation of this traffic control point from an air quality perspective. Local knowledge indicates that queues will quickly form towards Normandy roundabout and Morfa Terrace. What is in doubt is the actual extent of these queues and the knock-on effect in the real world. One avenue being explored is allowing the lights to remain on green phase except when activated by the express bus route, thus minimising delays and stationary traffic. If this is the final outcome of these deliberations then it is possible that southbound traffic may well be discouraged from using Neath Road as a southbound route anyway by the proposed road-narrowing etc.

As a long term goal, it may be desirable to actively use this point as a delaying tactic during periods where pollution is forecast to be high along Neath Road, to intentionally make Neath Road less attractive as a through route. As part of future enhancements to the computer modelling being developed (see chapter 5) it would be advantageous for this system to take control of any SCOOT type systems in operation when a likely occurrence of a pollution episode is first predicted. This would apply not only in the lower valley area but also within other areas subject to the model predictions. Messages could be broadcast in this vicinity to variable message signs along the A4067 at Cwm Level Road roundabout and the A4217 Cross Valley Link Road signs in an attempt to dissuade and divert traffic from Neath Road. The outcome achieved would however be a fine balancing act between improving conditions within the Neath Road corridor and possibly worsening conditions along Morfa Terrace and

Normandy roundabout. The situation at Quay Parade bridges is already nearing capacity and diverting southbound traffic along the A4217 Pentreguineau Road may prove detrimental to that area in the longer term.

4. Proposed Additional Measures

The following measures are currently either under consideration or are actively being pursued as part of this authority's formulation of its Action Plan. The cost-benefit analysis carried out (see Chapter 7) does not limit itself to within the strict confines of the boundary of the AQMA, but has account for any possible benefits outside of the AQMA, both in air quality benefits, and any other consequential non air quality effects/benefits.

The LTP provides amongst other things, the funding framework by way of Transport Grant (TG) bids to implement the authorities transport objectives outlined above. The LTP has identified the principle improvements and actions required to achieve these objectives. As would be expected, the vast majority of these transport objectives fit in well with the culture of air quality management. Both strategies have been developed with each other in mind, and have been "heading down the same road" to ensure they are mutually beneficial for a number of years.

The Action Plan relies on a number of the action points contained within the LTP to develop and maintain the modal shift necessary to deliver the improvements required within the AQMA. Additional measures are to be taken to attempt local traffic management within the problem area. These and others are outlined and discussed briefly below.

4.1 Park and Ride Provision

Park and Ride is a fundamental element of Swansea's Transportation Strategy, a view which was endorsed by successful bids in the first two rounds of

Transportation Bids. This has seen the construction of two of the four permanent park and ride sites identified in the Transportation Strategy. Temporary Park and Ride sites have operated for the Christmas period only at Landore and Brynmill from 1974. During the 1980's the Landore site became operational on Saturdays from its former site located at Morfa Playing Fields.

Park and Ride is, and continues to be, actively promoted by the authority. Prominent signage has been installed kerbside along the primary routes into Swansea advertising the service. In addition, signage on the M4 corridor through the authority's area also displays the availability of the Park and Ride provision at the two main sites.

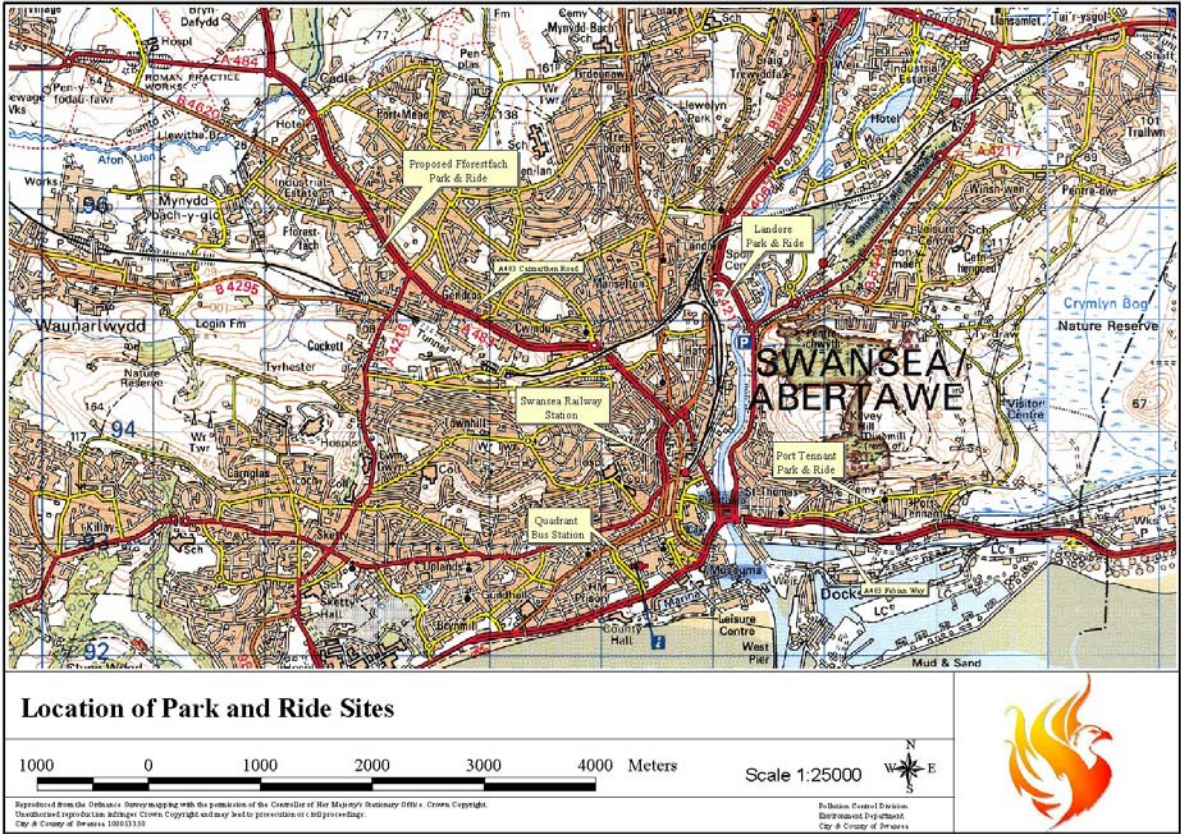

Map 4 Location of park and Ride Sites

There are plans to provide a third permanent Park and Ride site along the A483 leading from junction 47 of the M4 at Penllaergaer. This is discussed and outlined in 4.1.3 below.

4.1.1 Landore Park & Ride Site

The first site at Landore was opened in December 2000 at a site situated just off the A4067 between Normandy roundabout and White Rock Bridge, approximately one mile north of the city centre. The site has provision for 550 car spaces including specified disabled bays together with toilets (including disabled and baby changing facilities). In addition to car parking spaces, cycle racks are also provided.

The site is staffed during the opening hours of 06:45 to 1930 Monday – Saturday together with the site being covered by CCTV. Perimeter fencing makes this a secure car park which has been reflected in the achievement of the Secure Car Park award. The security of the site is seen as vital to ensure that motorists feel confident enough to use the site.

Buses run every 12 minutes between 07:00 and 19:00 to and from the city centre. A charge of £1.50 return per car, for up to four passengers is made. The services also operate on a Sunday for the 5 weeks prior to Christmas.

Patronage figures for the site between May 2002 and April show 52,766 car visit with 231,497 individual passenger journeys. Difficulties are being experienced of late in obtaining detailed patronage figures for usage at this site. These difficulties are currently being addressed but it is anticipated the figures will show the continued growth in popularity of the site.

Journey time is approximately 10 minutes but this will decrease with the provision of the dedicated express bus route from the site which when complete will avoid the congestion experienced along Neath Road. The scheme to provide

the express bus route has been incorporated into the Hafod Integrated Transport Study and works are ongoing to complete phase 1 by the end of 2004. Phase 2 which will see the route extend along the rear of properties on Neath Road is due to commence in 2005. This phase will see the express bus route linking up with Swansea railway Station. The service will terminate at the Quadrant Bus Station in the city centre. Details on phase 1 of the scheme are mentioned within chapter 3

4.1.2 Port Tennant Park & Ride (Fabian Way)

A site offering similar facilities to those at the Landore site has been established on the A483 Fabian Way, approximately one mile from Quay Parade bridges. The A483 is a major artery into the city centre and has a junction with the M4 (junction 42) motorway approximately two miles to the east.

Again, an express bus route is planned for the site. When complete, the express bus route will avoid the congestion seen at peak periods along the A483 leading up to the Quay Parade bridges and the entrance to the city centre. Phase 1 of the express bus route is due to commence during early 2005. Phase 1 will see the express bus route cross over the A483 Fabian Way utilising an old railway alignment, seeing the construction of a new “sail bridge” at this location. The express bus route will then run parallel with the A483 Fabian Way and adjacent to the new SA1 Development site and will merge with traffic at the Quay parade bridges junction. Future phases of this route will see it extended into the city centre itself.

4.1.3 Proposed Fforestfach Park & Ride Site

A site to serve the north of Swansea city centre is actively being sought. The site initially being assessed is a disused factory unit located off the busy A483 Carmarthen Road within the Fforestfach Industrial estate. The A483 has a junction with the M4 approximately 2 miles to the north of the site at junction 47. The city centre is approximately 3 miles to the south of the proposed site. Similar facilities are planned to that already provided at Landore and Port Tennant.

Development of this site is at a very early stage and negotiations to purchase the site are ongoing. When this site is established it is unlikely to see the provision of a dedicated express bus route into the city centre due to the limited space to develop such a route.

4.2 Improved Bus provision

The authority has used its revenue budget to ensure that most areas have at least a minimum level of service. This has meant however, that whilst a daytime service has been provided to some areas, an evening and Sunday service has not. In order to persuade the travelling public to seek the desired alternative modes of transport for their travel needs, this break in provision need to be addressed. These breaks in service will severely limit the ability of residents who have no access to private means of transport. These limited services may aspire those affected to seek car ownership as their means to travel to work and to socialise. To go some way to address these concerns, the authority has made use of the National Assembly's Bus Subsidy Grant thus ensuring breaks in service are kept to a minimum.

The authority has promoted bus priority routes, particularly, but not exclusively, in the city centre, in an effort to reduce bus journey times and to make public transport more attractive as an alternative to the car. This has included the use of bus lanes, bus gates, bus activated traffic signals priorities for buses and contraflow bus lanes. Some of these points are mentioned elsewhere within this document.

The authority is also currently funding a local concessionary bus fares scheme, designed to permit certain categories of people with disabilities to purchase tickets at a reduced rate. Elderly people are entitled to free, unlimited bus travel within the City and County of Swansea.

4.2.1 Bus Corridor Enhancements

The Council has Transport Grant funding to enhance the Neath Road and A48 corridors (Bus Priority Demonstration Corridor). The aim is to provide bus priority and improved bus facilities in order to encourage increased bus patronage. One of the main congestion points on the Neath Road corridor has been M4 Junction 45. The first stage of a scheme to improve bus and other movements was carried out in 2003, the second stage is planned to start in early 2005, with completion in late 2005. Works on enhancements to the A48 will be completed in 2005.

The original bus priority proposals for Neath Road are being reviewed. In partnership with First Group, the Council has commissioned a feasibility study for a new concept TramBus service linking Morriston Hospital, with the city centre, Singleton Hospital and Mumbles. The aim is to provide many of the advantages of a modern tram at a modest cost. It is envisaged that this service

will use the Landore express bus route, thereby avoiding much of Neath Road, and that bus priority will be introduced at key junctions.

Building on the information provided to passengers, variable message displays have been installed on a limited number of bus routes. These displays disseminate information to the passenger of the waiting time before the service is expected at that location, together with other service information. Information is updated on an almost real-time basis. It is anticipated that this service information will be expanded to other bus corridor routes as alluded to in the LTP.

To improve the accessibility of bus services for residents, who have limited mobility, the authority has worked with First Cymru, the main bus operator in the area to implement “Low Floor” Accessible Bus Corridors. With support from the Transport Grant process, the authority has provided roadside infrastructure compatible with the low floor buses operated by First Cymru. These improvements have been undertaken between the city centre and Townhill, Trallwyn, Treboeth, Brynhyfryd and Morrsiton bus corridors. The works undertaken include the raising of kerb levels, provision of road markings and bus clearway orders at stops. This scheme has seen the upgrading of the bus shelters at 93 stops with 21 new shelters provided. These improvements are ongoing and will be introduced within other bus routes in the coming years.

4.2.2 Enhancement of Bus and Rail Stations

The Quadrant Bus Station is the main pick-up and drop-off point for all local and long distance journeys that start and/or terminate within the city centre. It was constructed as part of the major Quadrant shopping complex during the late 1970's and early 1980's. The majority of the bus station complex is taken up with the space required for bus movements themselves. The passenger terminal is located immediately adjacent to the shopping complex and has been heavily

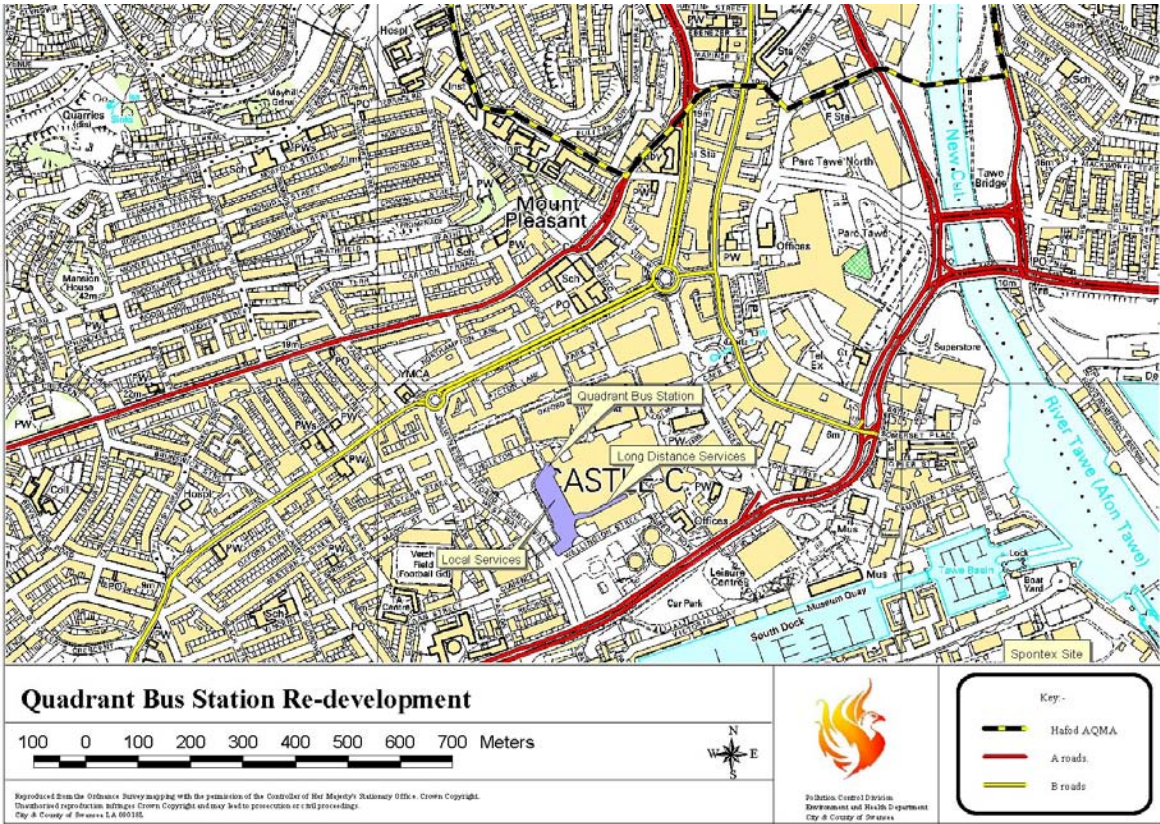

Map 5 Quadrant Bus Station

criticised both for its general condition and distance from Swansea Central railway station.

Discussions have partly explored relocation to provide an integrated service with the rail network. However, the feasibility and practicality of this option has not been explored fully. Current plans for the terminal have moved away from the above option, to more of a redevelopment and upgrading of the existing

terminal. The authority has now secured Transport Grant funding to redevelop the Quadrant bus station in order to provide a modern secure passenger friendly bus interchange. Outline planning consent has been granted and a compulsory purchase order has been served on the owner of the current bus pad. The Council has engaged architects and project managers to develop a detailed scheme. It is envisaged that a public inquiry will be held in 2005.

The effects on air quality will require assessment as a new access road is envisaged from Westway, controlled by traffic lights. A large sheltered housing complex borders and overlooks the already congested Westway which acts as a route to, and link from The Kingsway (via Dillwyn Street) to the north and west of the city centre down to Oystermouth Road to the south. Any impacts on the pattern and frequency of bus provision are not known at this stage.

The Swansea High Street Transport Interchange was completed in March 2004. Funded through a combination of Transport Grant and Objective 1, this scheme provides improved access to the railway station by bus, taxi and on foot, together with new public realm, improved security and improved parking facilities. The Council is now discussing with Network Rail and Arriva Trains Wales how to improve passenger facilities at the station itself.

4.3 Safe Routes to School

Swansea's Local Transport Plan identifies School Travel Plans and Safe Routes to School projects as key elements in the Authority's long term transportation strategy, because of their potential to achieve the Authority's transport objectives. In particular, such schemes can have a significant role in helping to

ease congestion, reduce pollution and encourage healthier and more sustainable travel patterns

The City and County of Swansea's Safe Routes to School Project dates from February 1997 when the Education Committee resolved to support the development a pilot scheme.

Two schools were selected to form the pilot project: Gowerton Comprehensive School and Talycopa Primary School. Both schemes were successful in gaining NAW funding in consecutive years.

The Authority's next main project was the Greater Gowerton scheme, involving 4 feeder schools for Gowerton School. The aim is to encourage more pupils to walk and cycle to these schools. An important reason for working with these schools is that changing the attitudes and travel patterns of these younger pupils will help to sustain the current Gowerton scheme. A local steering group has been set up and all the schools have demonstrated their commitment. In addition, there is good local community support for this scheme.

This scheme consists of four feeder schools of Gowerton School. Tregwyr Infants (232 pupils) and Tregwyr Junior (235 pupils) are both situated in the village of Gowerton. Waunarlwydd Primary (341 pupils) is in the adjoining village of Waunarlwydd, while Pen-y-fro Primary (223 pupils) is in the village of Dунvant.

It was thought that at all these schools the introduction of physical measures to reduce traffic speeds, improve crossing facilities and provide improved pedestrian routes would have a major impact in encouraging a change in travel patterns. The scheme was developed by the steering group in the autumn and

spring terms. Most of the physical elements of the scheme were implemented during 2001/02.

The Authority also worked with two other schools to encouraging more pupils to walk. These were Gors Primary and Sketty Primary. These are both low key initiatives, without specific resources identified to carry out physical works. Officer support is, however, being provided to work with the schools, pupils and parents. This type of project is seen as an excellent opportunity to assess what can be achieved without a major financial input and with modest support.

The Authority has published *Towards a Safer Journey to School*. This booklet is a self-help guide for teaching staff, governors and parents. It explains how Safe Routes to School schemes and School Travel Plans have been developed at both Gowerton and Talycopa. It suggest that all schools could benefit from introducing such schemes within their School Development Plan

Typical measures undertaken within a safe Route to School scheme include some or all of the points below. Obviously, specific proposals may relate to specific issues and may only be appropriate at certain schools

- Introduction of School Areas at the school entrances, with gateway signs, coloured surfaces and improved crossing
- Improvements to walking routes, including footway markings, improved crossing facilities
- Associated signing and traffic regulation orders
- Cycle shelter and storage at the school
- Lockers in the school (funded by RAC Grassroots award)
- Addition to school CCTV system
- Modifications to school drive Toucan crossing at school

- Traffic calming features, introduction of 20mph zones, village gateway signs (part funded by Community Council), school area (snail signs)
- Installation of lighting

The project is now at a stage where it can mainstream the lessons and good practice that have been learnt in the last five years and focus to a greater degree on the central objective of the scheme - to increase the number of pupils walking and cycling to the schools

The current failure of the project to achieve this objective, is in many ways a direct result of the criteria of the WAG funding stream it depends on. The central problem of the Safe Routes scheme is that funds are provided for capital projects only. This has focused the attention of the officers and the schools on the engineering work programme and has greatly limited the educational and promotional work that the Authority has been able to do. This in turn affects the ability of the project to achieve change in travel patterns.

Aside from the financial limitations of the scheme some concerns have arisen from the monitoring process including:

- A lack of clarity between schools and the Authority as to each other's responsibilities and expectations for the project.
- A lack of an effective monitoring system that would allow schools and the Authority to keep track of and respond to changes in travel patterns.
- Failures to effectively target the key travel decision-makers in the primary school age bracket. i.e. the parents.
- A lack of effective planning and co-ordination of the educational opportunities that would support the safe routes message.

- Missed opportunities in investigating and tapping into motivational triggers for young people.
- A failure to motivate and support schools into writing their own School Travel Action Plans.
- The creation of a certain dependency on the Road Safety officers within the schools to deliver travel and road safety education.

The Safe Routes to School initiative has been delivered in Swansea for the last five years. Appraisals show, a great deal of commendable work has been achieved during this period. Particular strengths of the programme have been: the creation of new working partnerships with schools and local communities, the development of participatory consultation, planning and design techniques, the sharing *of* expertise and skills between departments, unique design and promotion projects and the successful impact of speed control measures around schools

Early indications from the projects suggest that physical changes to the roads are not enough to bring about change in travel patterns. As traffic continues to increase on roads, there is a real threat that without addressing the above problems, the participating schools will continue to see a rise in the number of children travelling to school by car. Following the introduction of a scheme Road Safety Officers help to educate pupils and promote walking buses.

It is anticipated that despite some of the items mentioned above that the Safe Routes to Schools initiative will be expanded to other areas of Swansea in future years. Measures taken are likely to mirror but improve on, those taken within the pilot schemes .One such scheme is within the Gorseinon area. This scheme has built on the experiences of the pilots and has seen the introduction of vehicle

activated speed signs along the approaches to schools which advise the drivers of their speed, providing a visual incentive for the driver to reduce speed.

4.4 Vehicle Emissions Testing

The authority was one of the seven pilot authorities that first undertook vehicle emissions testing in the late 1990's. Equipment purchased as part of this pilot has been maintained and calibrated annually. However, its use has mainly been confined to advisory rather than an enforcement role. The reasons for this are twofold. Firstly, the operation is labour intensive and means that up to four staff are deployed for long periods, removing resources from other spheres of work. The major factor in the scaling down of enforcement action was the desire of the Police to introduce a charging scheme for the deployment of their officers and that officer time be limited to half a day. For these reasons, the activities to date have been scaled down to more of a public awareness of the issues on the reliance on private transport at local supermarkets etc. Motorists shopping at the supermarkets could choose voluntarily to have their vehicles tested. It is planned to carry on the advisory role but to supplement this with active enforcement of the regulations (when made) with stop checks within the problem area. This action will be dependent upon the continued willingness of the Police to assist and staff resources.

4.5 City Centre Car Parking

The availability of car parking is a major influence on the choice of mode of transport. A fine balancing act has to be undertaken between ensuring the economic survival of the city centre shopping area and preventing congestion due to insufficient parking provision. The authority operates 3 multi-story car

parks within the city centre at the Quadrant, St.Davids Shopping Centre and High Street Station. In addition, surface car parks are operated throughout the city but the numbers of spaces available are dwindling as these surface sites are developed.

Variable message signs have been located on the approaches to the city centre at Uplands, The A483 Oystermouth Road at the Slip Bridge, Dyfatty Street and Quay Parade. These signs display available car-parking spaces available within the multi-storey car parks operated by the authority in almost real-time. It is hoped that these will allow the motorists to determine whether it would be advisable to use Park and Ride or an alternative mode of transport to the city centre. No information is presented at present for the surface pay and display car parks.

City centre car parking charges are likely to increase in future years. Whilst this may persuade some motorists to use the other forms of transport available, it is unlikely to solve the long-term problem of a shortage of parking provision within the city centre.

Local residential areas i.e. the Sandfields area have seen an increase in use of residential side streets as parking for city centre shopping. This may be two-fold due to the limited spaces available, coupled with increase in charges. This has led to designation of numerous streets as residents only parking zones and lately, investigations into the feasibility of Voucher Parking schemes. Plans to introduce the Voucher Parking Scheme have seen considerable local opposition.

4.6 Travel Plans

Travel Plans are a series of objectives, policies and practical measures by which an organisation manages the effect of the traffic that its activities generate. All organisations have a traffic impact, be it staff commuting to and from work, deliveries or collections of goods etc. A Travel Plan will examine each activity and develop proposals to reduce their impact on the local environment.

The planning process can play a major role in the introduction of Travel Plans. Policies are under consideration setting out where it would be appropriate for planning applications to be supported by a Travel Plan.

Travel Plans have clear benefits for Swansea, and include:

- A reduction in car use and an increase in car occupancy - this would lead to a reduction in congestion and therefore pollution.
- Greater use of public transport, walking and cycling – encouraging a healthier population via exercise
- Improvements in road safety
- Measures to reduce the impact of delivery and service vehicles
- Reduction in stress levels
- Greater choices of travel options.

The authority started the process of developing a Travel Plan for its staff during late 2000. Policies under development include investigating the following methods to encourage a change in travel habits:

- Negotiating improved bus services

- Negotiating discounts on bus and rail season tickets
- Improving cycling facilities
- Improved pedestrian access to and from its buildings
- Developing car sharing schemes
- Where appropriate, allowing staff to work from home
- Developing bicycle user groups
- Greater use of pool cars and bikes
- Greater use of bus and rail services for business journeys – both within and outside of the authority.
- Consolidating deliveries and collections.

The Travel Plan is also considering less favourable options (from a staff perspective) such as parking charges (included within the Voucher Parking Scheme mentioned in 4.5 City Centre Car parking above) in conjunction with reducing the car parking facilities offered.

The Travel Plan outcomes are being monitored and ongoing promotional work continues. The authority intends to commit the necessary time and resources to the Travel Plan in recognition of its value as a means of encouraging modal shift.

As well as working on its own Travel Plan the authority has been keen to encourage other organisations to develop suitable plans themselves.

Organisations developing their own plans include:

- Driver and Vehicle Licencing Agency (DVLA)
- Singleton Hospital
- Morriston Hospital

- Swansea University
- Swansea Institute
- The Benefits Agency
- Inland Revenue
- HSBC Bank Ltd.

Swansea University and Swansea Institute have already formed a Higher Education Green Forum where Travel Plans are discussed in the context of other sustainable issues such as recycling. The authority is invited to these meetings and will continue to work with the Forum.

The authority and the Welsh Development Agency are also working in partnership on Travel Plans within Swansea. This work is focusing on the Swansea Enterprise Park to improve access to this important employment area where bus services are currently inadequate.

4.7 Enforcement of Bus Only Lanes

To continue the encouragement for the travelling public to make the modal shift required, the enforcement of the bus only lanes is seen as important to prevent the bus services from encountering delays. Enforcement of these bus only lanes is envisaged as taking priority within the city centre network.

Whilst inconsiderate parking of private cars is a problem (often as an attempt to access a cash machine for example) these, whilst short-lived undoubtedly, delay the bus services. The main long-term offenders are delivery vehicles.

4.8 City & County of Swansea Vehicle Fleet

Fleet management strategies have been designed to underpin the Council's environment policies, and in particular the 'Clean Air Charter' to improve air quality for residents of, and visitors to, Swansea and surrounding areas.

Corporate planning has set targets for the continual "greening" of the vehicle fleet by 10% per annum, and with 175 dual-fuel L.P.G. vehicles introduced since March 1999, the authority now manage Wales' leading local authority "Green Fleet". This fact has been continually recognised in the City and County of Swansea receiving numerous environmental fleet awards as outlined below,

- Runner-up in the National Green Fleet Awards in 2001 and 2002
- National Champion in the Green Apple Environment Awards for Commerce and Industry 2003
- Wales runner-up in the Green Apple Environment Awards for Local Authorities 2003

With 40% of the potential green fleet vehicles converted to L.P.G., other bespoke solutions have been implemented to assist in managing down the environmental impact of a 750 vehicle fleet operation within the Council's area. These include,

- A robust time based maintenance and inspection regime that specifies oil and filter changes twice a year
- A rolling 5 year programme of vehicle renewals to consolidate technological advancements within the fleet

- Detailed consultation with users on specifications to ensure maximised utility for the supplied vehicle
- A replacement component strategy that “ builds in “ disposal and recycling requirements for tyres, oils, batteries, cleaning products, asbestos free linings etc
- Active pursual of Energy Savings Trust grants for dualfuel vehicle provision that totals in excess of £120,000 to date
- Establishing a refuelling site within our primary operational depot for L.P.G. vehicles, in partnership with Flogas, and extending the use of this facility to other dualfuel users such as the D.V.L.A., taxi associations, local businesses and private individuals.
- Specifying Eminox Continuous Regenerating Particle traps (CRTs) and Euro 3 compliant engines on new heavy commercial vehicles
- Retrospectively fitting CRTs to existing ordered vehicles and applying for the Wales Assembly Government grants in support of this
- Introduction of Low Sulphur diesel to the Council’s fuel stocks

The authority actively enforces a “ good neighbour “ approach in terms of the Council’s driver conduct, vehicle operations and parking arrangements.

4.9 Quay Parade Bridges

As mentioned elsewhere within this document Quay Parade Bridges are subject to significant peak hour congestion affecting all vehicles. A study has been carried out to assess whether a gyratory or alternative traffic arrangement could provide additional traffic capacity and thus ease congestion. A signal controlled gyratory scheme was assessed to be the best alternative to the existing

arrangement, however it had significant and unacceptable negative impact on local traffic and some bus services.

As an alternative the Council has commissioned a recalibration of the traffic signals at Tawe Bridges together with those in Quay Parade/Victoria Road/Oystermouth Road. The aim is make more effective use of the existing highway network. In parallel options for extending bus priority across Quay Parade to Oystermouth Road are being investigated.

In order to monitor the air quality within the immediate vicinity of the junction, an OPSIS DOAS open path measurement system is to be installed along a 300-metre path running parallel to Pentreguinea Road. These terraced dwellings are the more likely to suffer the adverse affects of congestion around this junction. The data obtained from this DOAS system will enable an assessment into the effectiveness of the re-calibration of the signals within the immediate road network as well as any effects of the intended policy to encourage traffic from the B4603 Neath Road central valley corridor to this area. This movement away from the central route is intended to be effective in both a northbound and southbound direction and will rely on the effectiveness of any measures taken to reduce congestion at the bridges/Fabian Way. The data will be closely examined to establish if the intended course of action is indeed the more appropriate and not degrading air quality further at this location.

4.10 Cycle Provision

This authority has adopted the aims of the National Cycling Strategy to double cycle use by 2002 and then to double it again by 2012. This policy has become an integral part of the Transportation Strategy and Local Transport Plan.

In Swansea, cycle use is lower than the national average. Data from the 1991 census indicated that only 0.9% of journeys to work were made by bicycle compared to the 3.5% national average. Swansea's topography may explain this pattern (see map 3) with the coastal strip and outlying urban areas served by steep roadways etc. Data from the 2001 census has been examined to see if the policies already in place had developed the use of cycling further. A first glance at the figures compiled for Swansea show that travel to work by cycling has increased to 11.09%. However, upon closer examination of the figures it is clear that the version of the 2001 census available has grouped cycling with travel to work on foot and other. Further enquiries have been made and upon closer examination of the dataset cycling, as a method of travel to work, when separated out, is given as 1.16%, or 1024 people. There has therefore been a very small increase in cycle use for work related purposes over the 1991 data.

Two routes of the National Cycle network meet in Swansea. Route 4, the Celtic Trail is being developed through a variety of external funding sources and a joint consortium of local Authorities. Route 42, the Swansea to Builth Wells route, is currently open between St. Thomas and Morriston. Further works will be undertaken to extend this route through to Clydach and Pontardawre. Route 42 has seen some of these planned improvements undertaken as part of the development of the Swansea Vale Scheme in Morriston. This scheme sees a mixture of distinct, separate village development mixed in with areas of industrial use, separated by high quality landscaping schemes. Recreational use of the designed open spaces will be encouraged through the extension of the footpath and cycle networks along the River Tawe. Proposals have been made to provide for up to 1800 new homes on approximately 132 acres of the site. Provision of the enhancements to Route 42 will allow these residents the opportunity to cycle directly into the city centre and beyond adjacent to the river Tawe.

Existing off road cycling network requires much work to improve off-road facilities for leisure and utility cycling.

As stated in the Local Transport Plan, the authority's aspiration is that all local journeys should be made easily and safely by bike. Many new cyclists, for personal safety reasons have expressed a desire for development of off road routes, whilst established cyclists prefer to use the road network, often because it is faster and provides a more direct route. Any cycle network developed will need to consist of a combination of both off and on-road routes.

As funding streams to develop the desired network are limited, it is thought sensible to concentrate on areas where there is the greatest potential for cycling. These areas would be along the coastal route i.e. to and from the University, and city centre. Other areas to concentrate on will be colleges and schools (see Safe Routes to Schools sec 4.3 along with links to the National Cycle network and places of employment ie Enterprise Zone, Tawe Vale etc.

The authority has set four cycling objectives within the LTP:

- To maximise the role of cycling as a transport mode and to achieve a change in modal split, away from private car use to the more sustainable mode of cycling, walking and public transport
- To develop safe, convenient, efficient and attractive infrastructure of a quality which will encourage cycling as a mode of transport and which will reduce reliance on, and thus discourage unnecessary use of private transport.
- To ensure that policies are designed to increase the numbers of people cycling or the proportion of trips made by bicycle, and that the needs of cyclists are fully integrated into the UDP, LTP, the Road Safety Plan and all

other complementary strategies including environment, education, health, leisure, equal opportunities and anti-poverty strategies.

- To continue to monitor and review facilities and cycle use with the intention of developing accurate records, profiles and trends, and to assess whether targets are being achieved. This will ensure the strategy remains alive.

The main priorities for action include:

- Completion of the national Routes 4 and 43 and the main feeder links to High Street Station, Pontardulais and Penclawdd
- Routes into and through the city centre
- Routes to the University and its student villages, Singleton Hospital with the Celtic trail
- Routes servicing schools, colleges and workplaces

The authority has made provision for its own staff by providing cycle storage at the majority of its sites. Use of cycling has been promoted and encouraged by the provision of shower and changing facilities at its main sites.

The authority has also adopted two targets for cycling within the LTP:

- The completion of the National Cycle Network in Swansea by 2005
- Triple cycle use (as monitored by the cycle counters on the NCN) by 2010 in comparison to the base year of 2000

4.11 Local Rail and Long Distance Rail Services

Railtrack has established local stations over the last several years primarily servicing the “Swanline” local rail service. These stations have as would be expected been established within the outlying urban areas of Swansea at Llansamlet, Gowerton, Pontardulais and Skewen (outside the authority area). Secure parking facilities are provided at the majority of these stations. Use of the Swanline services over the last 5 years has been disappointing, partly because easy to remember timetables have not been offered and also because no sustained marketing effort has been made to promote its use.

Swansea railway station has recently seen a major enhancement of the entrance to the station and the provision of short-stay parking opposite the station together with dedicated pick-up and drop-off points to the side of the station entrance. Long stay is possible via the secure High Street multi-story car park to the rear of the complex.

Swansea is served by the mainline Inter-City route to London as well as services to West Wales and the Heart of Wales. Whilst services are generally adequate there is room for improvement. Passengers may be detracted from using rail to travel “locally” i.e. Cardiff because, the number of stops this service makes results in a slow service. Rail journeys are unable to compete with car journeys to Cardiff in terms of speed. A similar situation exists with journeys from Pontardulais into Swansea but this is unattractive due to the indirect nature of the service via Llanelli.

To the east of Swansea there is the need therefore to upgrade the mainline to promote increased line speeds, provide a smoother journey and thus encourage

operators to invest in faster trains. The proposed All Wales Franchisement and Railtracks proposals for the Great Western Renaissance (confirmed in Transport 2010) offer the prospect of improved rail services.

4.12 Taxi Services

It is possible to forget that taxi services are a form of public transport. Taxis provide a valuable service to Swansea residents, particularly those who are not car owners and have limited access to bus services or those who wish to transport bulky shopping goods home. What is often forgotten is that they provide a means of integration with other modes of travel such as rail or long distance coach services.

It is possible under current legislation for taxis to carry a group of passengers at separate fares. This would equalise the costs of bus and taxi transport for individuals, and assist those without cars or adequate bus services. However, the approach has not been adopted in Swansea. Taxi services are more expensive per mile than bus services but this is offset by the door-to-door service offered.

There are at present, 321 Hackney Carriage Vehicles and 340 Private Hire vehicles licensed by this authority. As part of this licence officers of the authority check the vehicles every 6 months for road worthiness. These checks do not regrettably include exhaust emissions testing. The authority relies on the annual MOT test for this information for vehicles older than 3 years. The authority has a policy of only licencing vehicles less than 5 years old.

Closer co-operation is needed with taxi operators to raise standards of customer care. This will mean that vehicles and drivers are better able to meet the future needs of Swansea residents.

5 Traffic Management Systems with Air Quality Monitoring Feedback - Nowcasting - Computer Modelling and Traffic Management.

To build on the works outlined in the previous chapters, specifically chapter 3.3, it is the intention to build a bespoke computer modelling application that will aid in the management of traffic flows during, and leading up to, forecasted pollution episodes. These measures are seen to complement the hard, physical measures to be taken on the ground primarily within the Neath Road corridor and will enable members of the travelling public to make reasoned decisions over their travel plans within the lower Swansea valley area.

5.1 Overview

The authorities' intention is to develop a working, near real-time traffic emissions forecast model. The model chosen for this work is the Nowcaster traffic model from OPSIS Ltd of Sweden. Specific enhancements to the model are being developed by OPSIS to meet this authorities' requirements. The model will compute pollution loading along the primary routes, initially located within the lower Swansea Valley road network every hour or more frequently if this proves necessary. It is the intention to expand the forecast area in future years to cover the majority of the authorities' area. The model will have an interface with variable message signs and will broadcast specific messages to specific signs in an attempt to manage the traffic flows.

5.2 Data Requirements – A Brief Overview

In order to operate, the Nowcaster model requires the construction of an emissions database. This database is in the process of construction and will identify and classify every road within the City & County of Swansea. Details of road width, pavement width and the distance and height of buildings on each road section will be input into the emissions database. All industrial, point and area sources will be defined and included onto the database. Emission factors will then be determined for each source.

A major data input into the Nowcaster model, is the requirement for detailed traffic flow information on an almost real-time basis. As a very limited dataset existed prior to the air quality management works, a major investment has been made to make the required dataset available for use by the models. The installation program has been split into an initial two phases for the financial year ending 31st March 2005. Phases 1 and 2 of this project will see 40 GPRS (General Packet Radio Service) Automatic Traffic Counters (ATC's) installed within the road network to the lower Swansea Valley area. The ATC's have been configured to produce a vehicle by vehicle classification to the EUR6 standard as shown below, along with the speed and direction of the vehicle.

Class	Description
1	Motorcycle
2	Car or Light Van
3	Car or Light Van with Trailer
4	Heavy Van, Mini Bus, LGV, MGV or HGV
5	Articulated Lorry, HGV and Trailer
6	Bus

EUR6 – Vehicle Classification

Vehicle by vehicle data is transmitted via the GPRS network to dedicated FTP servers located within the authority, in blocks of 5-minute data. The data path

taken from the ATC via the Vodafone GPRS network can be seen in diagram 1 below. For security purposes the data passes through a secure IPSEC Tunnel and is terminated via a Cisco Pix device at the FTP site. Please note that all IP addresses given in diagram 1 are false for security considerations, and are intended for illustration purposes only.

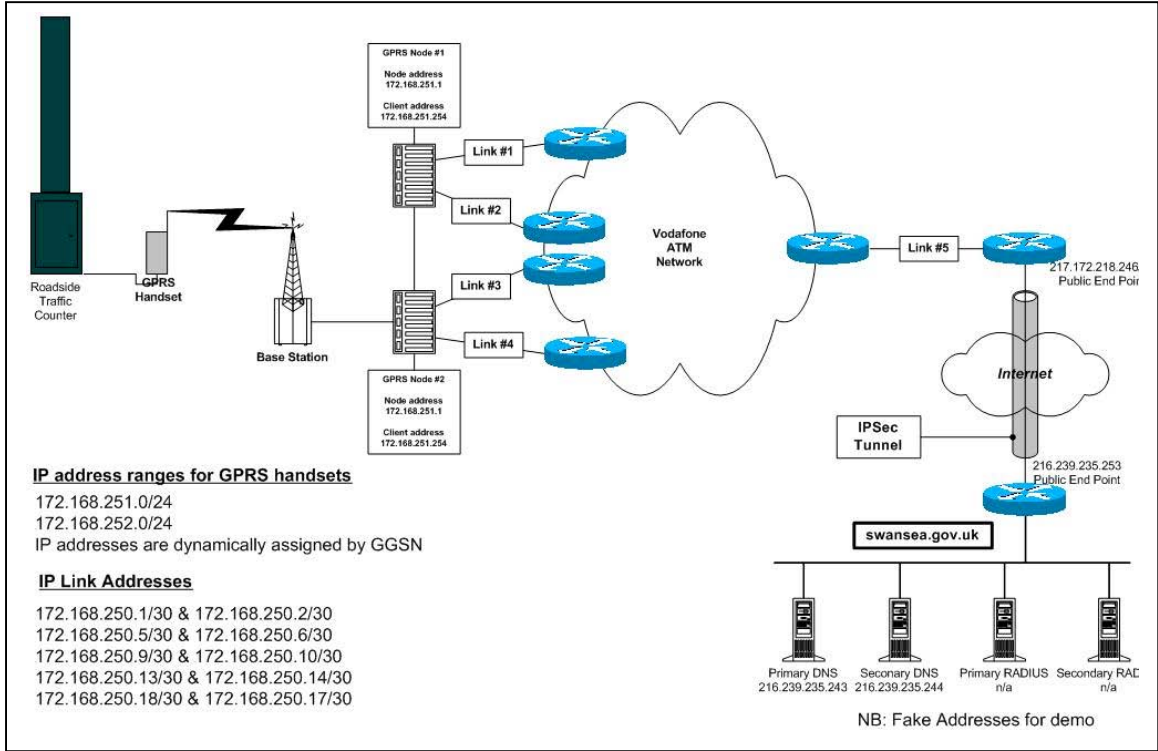

Diagram 1 – Schematic of GPRS data system and path

The infrastructure to facilitate this data transfer did not exist prior to the air quality management works and has been built up over the last two years requiring significant investment in information technology systems. This has seen the introduction of two FTP servers’ to handle the traffic flow data alone. Further phases of this air quality management project will require additional substantial investment in IT, traffic counting, variable message signs and air quality monitoring systems.

Meteorological data will be received via FTP from the Danish Met Office. The forecast will span three days as hourly time series. The forecasts will be updated four times every day, initialised at 00, 06, 12 and 18 UTC. The weather forecasts include the following parameters: Wind speed (10 m, 80 m and 800 m), wind direction (10 m, 80m and 800m), temperature (2 m, 80 m and 800 m), mean sea level pressure, precipitation (convective, stratisform and snow), boundary layer height, friction velocity, surface heat flux, relative humidity, and cloud cover (low and high).

Real-time air quality data will be processed from the three monitoring sites at the Swansea AURN, Morfa Groundhog and Morryston Groundhog.

A vital requirement of this project is to validate the output of the Nowcaster model. This can best be achieved by validation of the predicted output of the model by measurement of real-time air quality data along a typical congested street. Neath Road has been chosen as the validation point.

An OPSIS DOAS open path light source measures the pollutants Nitric Oxide, Nitrogen Dioxide, Ozone and Benzene along a 250-metre section of Neath Road. These measurements take place at first floor level - a height of



Picture 1 – Hafod OPSIS DOAS Receiver, Neath Road



Picture 2 – Hafod OPSIS DOAS Transmitter, Neath Road

approximately 3 - 4 metres. The DOAS transmitter is fixed externally to the front wall of a terraced dwelling on Maliphant Street that fronts onto Neath Road at one end of the open path measurement. The receiver module is located on the front wall of a commercial premise opposite the Bowen Street junction that also fronts onto Neath Road at the other end of the 250 meter open path measurement length. The monitoring location allows measurements running parallel to the carriageway and approximately 18” from the front façade of the terraced dwellings of the above mentioned pollutants to be made. The carriageway of Neath Road is approximately 2 metres away from the front façade of these terraced dwellings. These data will have a resolution of 3 minutes and will be used to determine and evaluate the atmospheric chemistry responsible for the formation of NO₂ (and O₃) within the street, as well as the



Picture 3 Hafod Post Office meteorological Station

validation of the predictive output from Nowcaster. As part of the validation process, vertical and horizontal wind speed and wind direction measurements will be taken at first floor level at Hafod Post Office, Neath Road. Horizontal wind speed and wind direction will also be recorded from above roof ridge level.

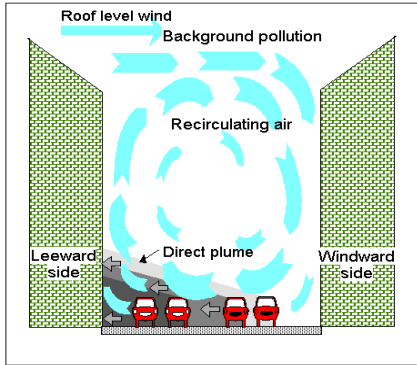

Illustration 1 – Street Canyon Mixing Vortices

Global radiation, ambient air temperature and relative humidity will be measured at first floor level at the Hafod Post Office site. These measurements will have a resolution of 1 minute and will aid the definition of the vortices and mixing capacity of the street “canyon” – vital information if the model is to be properly

validated.

The Nowcaster model will have the OPSIS EnviMet server module running in the background, compiling climatological datasets from the meteorological stations located at the Guildhall, Morfa Groundhog, Morryston Groundhog and the Hafod Post Office. Nowcaster will receive input parameters from all generated climatological datasets to enable an accurate forecast to be made.

A brief schematic diagram representing the major data input parameters and predictive output of the Nowcaster model can be seen below in diagram 2.

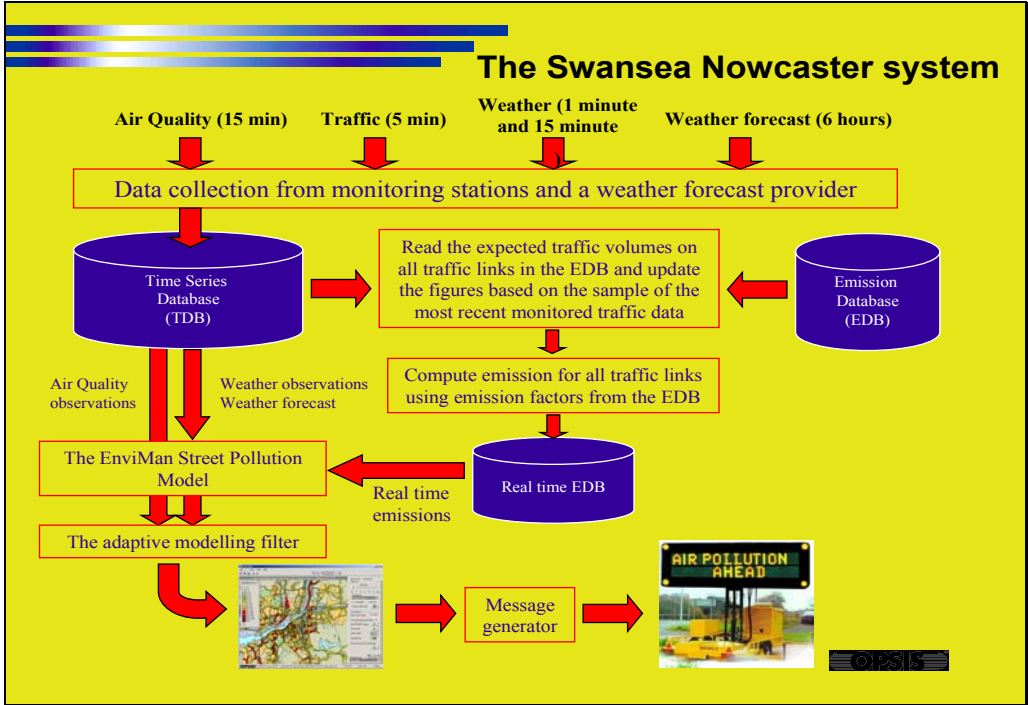
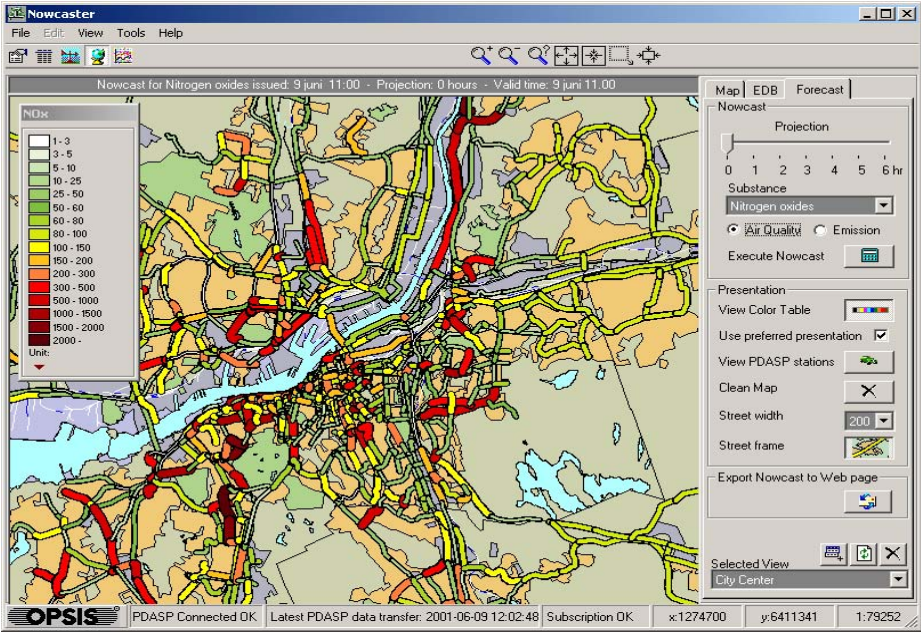

Diagram 2 – Nowcaster data parameter inputs and predicted output.

5.3 Predictive Output

Nowcaster will perform several tasks in predicting hourly pollution levels within each road link. Firstly, output will be in a colour coded graphical form on a pre-defined digital map – see example output produced within Gothenburg, Sweden

below. An unlimited number of views will be possible, either focusing down to a couple of streets or junctions, or looking more strategically at the road network as in the example shown below from Gothenburg. Pollution loadings for the various pollutants will be graded according to a colour scale. These maps will be



Example Nowcaster output from Gothenburg, Sweden

uploaded to web pages every hour and will give a visual indication of existing pollution levels together with hourly predictions for up to 8 hours into the future.

It is intended to link the model Nowcaster with the Variable Message Signs Ltd



Picture 3 – Example of Variable Message Sign

interface TRAMS. Variable Messaging Signs Ltd; are customising the TRAMS interface to integrate it within the Swansea project. Nowcaster will send status signals to TRAMS for those section(s) of road links that are/may exceed predefined pollution levels. Variable Message Signs will be sited strategically on the road infrastructure,

initially within the Lower Swansea Valley area.

Subsequent years of this project will see this provision expanded to other areas. Provision of the required variable message signs will require significant investment of capital monies to enable satisfactory coverage of the road network.

TRAMS will have been pre-programmed with a set of logical instructions to determine which sign receives which message for the existing/predicted condition, as not all signs will receive the same message. This ability to forecast conditions ahead, allows an opportunity for management of the traffic flows in the lower valley area and for the traffic to be redirected away from area(s) identified as likely to experience pollution incidents.

The messages displayed by the signs will encourage use of alternative modes of transport at every opportunity. The day to day operation of the signs is likely to be advisory i.e. making the motorist aware of any specific delays or planned road maintenance. Day to day operation can be initiated via manual input as and when specific conditions arise i.e. blockage of a route through roadwork's or an accident. Periods leading upto and during predicted pollution episodes would over-ride all routine messages displayed on the variable message signs.

It is planned to incorporate information relating to available parking spaces within the City Centre and at the authorities Park and Ride sites. This additional information will enable the motorist to make an informed decision regarding their final destination. Information will also be transmitted to the Variable Message Signs as a result of traffic speed/flow information received from the ATC's i.e. congestion/slow moving traffic ahead etc, as the system will be able to determine in real-time which direction slow moving traffic is being detected.

Development of the system is ongoing. Finalising the emissions database, extensive testing, and integration of the various systems and model output validation all remain to be completed.

6 Action Plan Consultation

Summary Action Plan consultation leaflets have been produced which outline in broad terms the measures intended to form the basis of the Action Plan. This leaflet was produced as A3 size and was forwarded to the following transportation organisations for their comments:

Bus Operators

- First Cymru, Heol Gwyrosydd, Penlan, Swansea.
- Hawkes Coaches, Bridge Road, Waunarlwydd, Swansea.

Train Operators

- Arriva Trains Wales, Haywood House North, Dumfries Place, Cardiff.
- First Great Western Trains, Milford House, 1 Milford Street, Swindon.

Freight Operators

- Freight Transport Association, Hermes House, 20 Coventry Road, Cubbington, Leamington Spa, Warwickshire.
- Road Haulage Association, Roadway House, Cribbs Causeway, Bristol.

Hackney Carriage

- Swansea Taxi Owners Association, Cnap Lwyd Road, Morrision, Swansea.

Cycling

- Wheelwrights, The Environment Centre, Pier Street, Swansea.
- CTC, Sketty Avenue, Sketty, Swansea.

User Groups

- Bus Users Group, PO Box 617, Gorseinon, Swansea.
- Welsh Consumer Council, Castle Buildings, Womanby Street, Cardiff.
- Rail Passenger Council Wales, St.David's House, Wood Street, Cardiff.

Disability Groups

- Swansea Access for Everyone, Heol-y-Scallen, Loughor, Swansea.

Business Groups

- West Wales Chamber of Commerce, 1st Floor, Creswell Buildings, Burrows Place, Swansea.
- Tourism South and West Wales, Pembroke House, Charter Court, Pheonix Way, Swansea Enterprise Park, Swansea.
- Welsh Development Agency, West Wales Division, Llys-y-Ddraig, Penllergaer Business Park, Penllergaer, Swansea.

A copy of the consultation leaflet forwarded to the above organisations can be seen in Annexe 2.

Response to consultation from the above groups has been disappointing. Only two replies have been received:

- The first, received via email, related to the request for all HGV vehicles to be permitted to use the dedicated bus lanes/routes. This has been noted but it is not proposed to consider this any further.

- The second was again received via email from CTC - *“CTC has joined an alliance of environmental groups to publish a report that examines why small-scale measures to improve local transport are so often overlooked in favour of big infrastructure projects in the appraisal of transport schemes. The report, Valuing the small: Counting the benefits, asks why the Government’s recommended appraisal methodology regularly undermines measures like safe routes to schools, 20mph zones and initiatives to improve cycling; it recommends that all proposals should be made to answer the simple question – will this increase or reduce our dependency on the car?”*

Roger Geffen, CTC’s Campaigns and Policy Manager, said: “The tendency to ‘super-size’ transport schemes by opting for the largest, most expensive projects leads to highly effective, but smaller value-for-money measures being overlooked. For example, research shows that cycle training encourages people to make over twice as many trips by bike and to cycle all year round – all for a relatively modest amount of investment.”

In response, as can be seen from chapter 4.3, the concerns regarding Safe Routes to School, 20mph zones and cycling provision are already being taken on board and developed, and included not only within this Action Plan but also within the authorities LTP.

An A4 leaflet has also been produced and can be seen within Annexe 3. This leaflet has been distributed within the Hafod community with copies left at the Hafod Renewals Office on Neath Road. No replies have been received.

Local ward members have requested a public meeting within the Hafod community to discuss the proposed action points to tackle both the poor air quality within the Hafod and traffic congestion. It is anticipated that any public meeting will take place in early 2005.

7 **Summary of Actions and Cost Benefits**

The Action Plan guidance clarifies the problem facing Local Authorities in carrying out a robust cost and benefit analysis but suggests issues which require comment including 5 key points. These will be addressed below:

No costs are being imposed on industrial operators over and above those required under the current EC requirements through IPPC or LAAPC.

The highest cost traffic management control strategy is the “Hafod By-pass” whilst favoured by some members of the public has been ruled out not only due to cost but because it is no longer practical or viable. In addition (and most importantly in terms of air quality) the nature of the secondary pollutants combined with the local topography make it unlikely to achieve target compliance in the long term.

The key concept of the nested model approach to *Nowcaster* is that all the many variations of traffic management in the valley corridor can be tested as “what if” scenarios and can then be “ground-truthed” by the monitoring data being sent in automatically from the ATC’s and the AQ monitoring network.

This infrastructure has to be the most cost effective long term investment as it also fulfils the statutory requirements to monitor air quality and assess traffic

flows/congestion etc. The data quality needed has increased the installation costs very slightly but this has produced large savings by increasing data capture and reducing staff costs.

The concept of using intelligent systems to optimise traffic flows and divert traffic away from areas about to fail a target, only when necessary, must minimise the costs to the users of the highway network and business operators in the area as the do nothing option or more draconian controls would both increase costs to some operators. Operating costs will fall to the Council but this will entail a relatively small increase in costs already incurred to operate traffic lights, SCOOT systems, car-park messaging etc. The plan will integrate some of these systems to minimise the number of days when air quality targets are missed. A small number of retailers (less than 10) may feel that any restriction on traffic flow on the Neath Road may result in trade loss. This is a circular argument as congestion and parking are already such a problem that passing trade is extremely difficult. These premises were always sited to service the local community and the Action Plan should improve that facility.

The approach outlined will also be critical when particle standards are tightened as it will assist in identifying and limiting the number of days failed.

There is no doubt that the health of local residents is being affected as many residents live in such close proximity to the problem highways and are experiencing unacceptable concentrations of certain pollutants. Earlier work carried out by the Council and not included in this plan demonstrated that Hafod residents, especially the very young and the elderly, are demonstrating effects or exposure to vehicle pollutants. One study on primary schoolchildren showed the classic delayed response in *Peak expiratory flow* when levels of PM₁₀ increased. Another local study using a biomarker on Neath Road residents showed that

they were environmentally exposed to Benzene. Although the epidemiology on Nitrogen dioxide is less clear COMEAP are still content that it is an important marker for traffic pollution exposure.

For these reasons the Authority are satisfied that it is very probable that the benefits of the Action Plan outweigh the costs.

Collated together here for ease of reference are the main action points mentioned within this document that are to be undertaken. It is envisaged that this will provide a clearer picture of what is proposed. No significance should be placed on the order that the points are listed.

As mentioned in the relevant guidance LAQM.G2(00) one of the key features of an Air Quality Action Plan is that some measure of cost-benefit analysis of the various options under consideration be made.

Whilst a formal cost benefit analysis has not been attempted what has been produced is an indication of the monitory sums thought necessary to effect the improvement, together with an indication of the likely impacts/benefits, be they air quality related or otherwise.

The monitory sums indicated have been banded thus:

Insignificant – meaning less than £10,000

Low – meaning less than £100,000

Medium – meaning £100,000 – £250,000

High – meaning greater than £500,000

Action Point 1: - Traffic management measures on Neath Road, including:

- Reduction of carriageway width
- Widening existing footways
- Creation of designated on street parking areas
- Junction radii increased
- Removal of the mini-roundabouts at the junctions of Neath Road with:
 - i. Aberdyberthi Street
 - ii. Tawe Avenue
- Removal of the traffic lights at the junction of Neath Road with Maliphant Street/Monger Street
- Maliphant Street to be made one-way eastbound
- Provision of “Puffin Crossing” south of the Maliphant Street and Neath Road junction
- Provision of raised crossing points at the junction of minor roads with Neath Road
- Provision of controlled pedestrian crossings at:
 - i. Cwm Terrace
 - ii. Bowen Street junction
 - iii. Outside 1351 Neath Road
- Informal crossing points with refuge islands
- Informal crossing points highlighted with surface treatment
- Provision of bus stops and shelters
- Gateway treatments to entrances onto Neath Road
- Creation of traffic control point

Cost	Effectiveness / Impacts / Benefits	Drawbacks	Date to be achieved
High	<ul style="list-style-type: none"> • Create deterrent to traffic from entering Neath Road • Provide traffic calming and smoother flow through Neath Road • Create improved conditions for local residents • Improve community spirit by reducing the “divide” that the road creates • Reduction of congestion caused by illegal parking • Improved bus facilities • Landscaping 	<ul style="list-style-type: none"> • Risk that deterrent proves ineffective • Risk that no improvements in air quality effected • Risk of moving congestion to Quay Parade bridges • Ironic risk of making Neath Road more attractive as a through route due to reduction in traffic 	Dec 2005

Action Point 2: Park and Ride provision

- Provision of Landore and Port Tennant Park and Ride Sites
- Development of Fforestfach Park and Ride site
- Construction of dedicated express bus routes serving Landore and Port Tennant Park and Ride sites

Cost	Effectiveness / Impacts / Benefits	Drawbacks	Date to be achieved
High	<ul style="list-style-type: none"> • Reduction of traffic within city centre • Reduced journey times via express bus routes make Park & Ride more attractive • Effecting modal shift required 	<ul style="list-style-type: none"> • Identification and acquisition costs of suitable sites 	<p>Being achieved now – ongoing commitment to provide additional facilities</p>

Action Point 3 : Improved Bus provision

Cost	Effectiveness / Impacts / Benefits	Drawbacks	Date to be achieved
High	<ul style="list-style-type: none"> • Ensuring that provision of minimum level of service is achieved • Encourage modal shift • Reduce bus journey times by creation of bus priority routes • Free travel for elderly and reduced fares for disabled 	<ul style="list-style-type: none"> • Frequency of services in outlying districts • Evening and Sunday bus services limited 	Being achieved now but ongoing provision desirable

Action Point 4 : Bus Corridor Enhancements

Cost	Effectiveness / Impacts / Benefits	Drawbacks	Date to be achieved
High	<ul style="list-style-type: none"> • Encourage increased bus patronage • Information disseminated to passengers via message signs • Accessibility to services by disable • Upgrading of bus shelters 	<ul style="list-style-type: none"> • Limited number of bus corridors improved 	Being achieved now but ongoing provision desirable

Action Point 5 : Enhancements of Bus and Rail Stations

Cost	Effectiveness / Impacts / Benefits	Drawbacks	Date to be achieved
High	<ul style="list-style-type: none"> • Encourage increased bus and rail patronage • Provide modern, secure passenger friendly facilities 	<ul style="list-style-type: none"> • Possible effects on air quality due to redevelopment of bus station • High costs 	Rail Station improvements completed 2004 – bus station unknown

Action Point 6 : Safe Routes to School

Cost	Effectiveness / Impacts / Benefits	Drawbacks	Date to be achieved
Medium	<ul style="list-style-type: none"> • Reduction in congestion at peak periods • Encourage healthier travel patterns • Encourage cycle use • Reduction of traffic speed outside schools • Reduction in child road accidents • Improved facilities • Education of motorists 	<ul style="list-style-type: none"> • Schemes to date have not effected the modal shift desired 	<p>Being achieved now but ongoing provision desirable</p>

Action Point 7 : Vehicle Emissions Testing

Cost	Effectiveness / Impacts / Benefits	Drawbacks	Date to be achieved
Insignificant	<ul style="list-style-type: none"> • Encourage motorists to adequately maintain their vehicles • Encourage change in makeup of vehicle fleet to newer vehicles • Reduction of gross polluters • Education of motorists 	<ul style="list-style-type: none"> • Police availability and charging • Staffing levels • Finding suitable locations 	Ongoing

Action Point 8 : Quay Parade Bridges Improvements

Cost	Effectiveness / Impacts / Benefits	Drawbacks	Date to be achieved
Medium	<ul style="list-style-type: none"> • Reduction of queuing at peak periods • More effective use of existing highway network • Improved capacity at junction • Measurement of air quality impacts by OPSIS DOAS 	<ul style="list-style-type: none"> • Outcome uncertain • Possibility of degrading air quality further • Possibility of capacity being exceeded 	December 2005

Action Point 9 : City & County of Swansea Vehicle Fleet

Cost	Effectiveness / Impacts / Benefits	Drawbacks	Date to be achieved
High	<ul style="list-style-type: none"> • Leading by example in changing to greener fuels • Ensuring vehicles adequately serviced and maintained 	<ul style="list-style-type: none"> • Location of facilities • Costs • Overall benefits/effects likely to be minimal on their own 	Ongoing

Action Point 10: Traffic management Systems with Air Quality Monitoring Feedback – Computer Modelling

Cost	Effectiveness / Impacts / Benefits	Drawbacks	Date to be achieved
High	<ul style="list-style-type: none"> • Development of “early warning” system for pollution episodes • Dissemination of information to motorists via signage • Measurement of air quality improvements • Measurement of change in travel patterns via traffic counters • Determine composition of traffic • High quality data from automatic traffic counters and high resolution air quality data 	<ul style="list-style-type: none"> • Information technology system costs • Motorists co-operation unpredictable • Costs of the various technology • Effects unknown • Development time for bespoke software • Collating of emissions data complex 	<p>System to be proven by December 2005 – further development ongoing</p>

Appendix 1

Origin-Destination Surveys

Three 12-hour, origin-destination (OD) roadside interview surveys were carried out in July 2001 by sub-consultant Paul Castle Consultancy, commissioned by Oscar Faber (<http://www.oscarfaber.com>) as part of their report to this authority dated February 2002 - The Hafod Integrated Transport Study.

Three separate studies took place along the B4603 Neath Road, the A4217 Pentreguineau Road and the B4489 Llangyfelach Road, all within the lower valley area and are either contained within or close to the area covered by the Hafod Air Quality Management Area.

The findings of these OD surveys have been taken from the submitted final report dated February 2002

- B4603 Neath Road – 15% of the trips originated in the residential areas adjacent to junction 45 of the M4 in the Ynysforan, Cwmrhydyceirw and Ynystawe areas. Parts of Birchgrove, all the areas surrounding Neath Road and Fford Cwm Tawe, and the Pontardawe/Ystalyfera hinterland to the northern extent of the upper Swansea Valley are all substantial generators of traffic.

15% of the surveyed traffic along Neath Road was bound for the city centre shopping area and a further 12% to the area around Swansea railway station. Remaining trips are widely spread between other central areas of Swansea and locations further afield i.e. the Gower Peninsula.

- B4489 Llangyfelach Road – the majority of drivers using this route had begun their journey in the suburban area adjacent to Llangyfelach Road i.e. Brynhyfryd, Landore, Manselton, Treboeth, Mynyddbach and the

village of Llangyfelach itself. The remainder were travelling in from various surrounding areas and the rural area beyond the M4 at Llangyfelach.

19% of the surveyed traffic was bound for the city centre shopping area/Quadrant whilst the railway station and Parc Tawe Shopping area were also important destinations.

- A4217 Pentreguineau Road – A large proportion of the surveyed traffic originated as would be expected from the eastern areas of Swansea i.e. Winch Wen which accounted for 14% of journeys with other areas such as Llansamlet also featuring prominently.

5% of trips originated outside of Swansea which suggests that this route may be being used by motorway traffic. Junctions 44 and 45 of the M4 are within easy reach of this location.

From this admittedly brief snapshot in the lower valley area an overall impression of the journey purpose can be gained from the roadside interviews and these are listed below in table 5.

Purpose	% of Total
From home to work	22.1
From home on employers business	1.7
From home to education centre	1.3
From home to shops	15.3
From home on personal business	8.7
From home to visit friends	3.3
From home to tourist attraction	0.1
From home for leisure	5.9
Other trips not starting from home	41.6
Total	100

Table 5 – Roadside Interview Surveys June 2001 – Source Oscar Faber, June 2001

From the above, it can be assumed that a large proportion of the vehicle movements in all probability originate from outside of the problem area. In the absence of any more recent Origin Destination studies directly from within the problem area, it was felt worthwhile to try and quantify those vehicles whose origin was likely to be from within, or close to, the Hafod AQMA. In the absence of the “O-D Surveys” as mentioned above and detailed traffic flow information, the recent 2001 Census was examined, if for no other reason than to try and understand the possible movements both from within and into the AQMA at peak times. This assumption relies on the knowledge of probable start and end journey points and it is thought it may present a better overall picture due to the data quantity and quality of the underlying Census dataset. Details can be found in section 2.2 within the main report body.

Appendix 2

Summary of Action Plan Measures

- ❖ Promotion and Provision of Alternatives – travel plans; safer routes to schools; improved walking and cycling facilities; park and ride provision; enhancement of bus and rail stations; improved Internet access to information.
- ❖ Managing The Road Network – enforcement of bus only lanes; improved bus provision; bus corridor enhancement; bus priority routes; intelligent traffic signals; traffic management at pollution 'hot spots'; removal of existing Neath Road traffic management schemes; improvements at Quay Parade Bridges.
- ❖ Emission Management – roadside testing; promote/pilot alternative vehicles/ fuels; encourage the use of natural gas for diesel HGVs; city centre car park charging schemes.

If you would like to tell us your views or require further information then please contact us either

on

01792 635600 Pollution Control Division;

or

e-mail pollution@swansea.gov.uk;

or

www.swansea.airqualitydata.com

or

write to Pollution Control Division,

Environment Department,

City and County of Swansea,

The Guildhall, Swansea

SA1 4PE

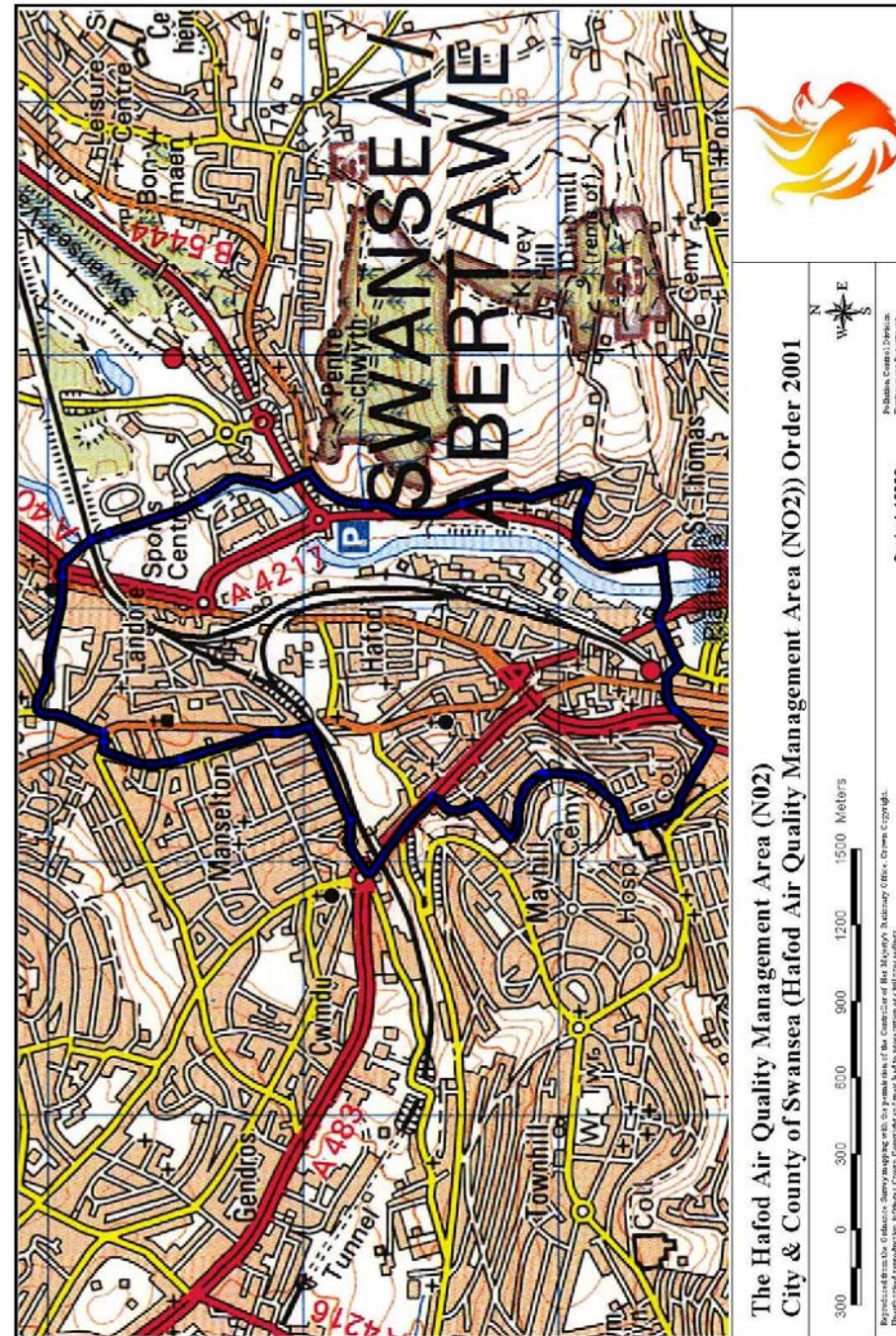

CITY AND COUNTY OF SWANSEA
DINAS A SIR ABERTAWE

AIR QUALITY ACTION PLAN FOR SWANSEA



The Environment Act 1995 introduced legislation for the local management of air quality. Part IV of the Act introduced a statutory duty for local authorities to review and assess the air quality within their districts and to identify those areas where further local measures would be required to achieve the air quality standards and objectives.

The National Air Quality Strategy was published in March 1997, establishing standards for certain key pollutants and outlining national and international policies to reduce air pollution levels by 2005.

The Air Quality (Wales) Regulations 2000 set the statutory objectives for local authorities for 7 air pollutants (benzene, 1,3-butadiene, carbon monoxide, lead, nitrogen dioxide (NO₂), fine particles and sulphur dioxide) to be achieved by 2005. The objectives were based on the pollutant effect on human health.

The City and County of Swansea undertook a comprehensive multi-staged review and assessment of air quality within its boundaries and was able to identify those areas that would exceed the national objectives. Following this an Air Quality Management Area (AQMA) was declared in the Lower Swansea Valley. This is referred to as the Hafod Air Quality Management Area (NO₂) because Hafod was likely to fail the statutory NO₂ objective, which was to be achieved by 2005.

In order to improve air quality within an AQMA a specific Action Plan is required.

After several feasibility studies and a lot of preparatory work Swansea are now satisfied that the outcome of the Action Plan will provide a practical delivery of the improvements required.

A summary of the proposed measures being considered or those, which are being pursued actively, have been provided on the back of this document.

In a ground-breaking Action Plan that brings together cutting-edge technology from a number of different fields, the City and County of Swansea is introducing a traffic management programme to both improve traffic flow and reduce pollution in the Lower Swansea Valley area of the city. It is hoped that this 3-year capital programme will be the forerunner of similar measures to be taken in critical areas across the city.

The primary routes through the Lower Swansea Valley road network are major commuter links to the city centre. It is planned that, when the programme is in place, motorists using these routes will be advised in advance not only of traffic congestion, but also of pollution levels along the route.

Available car parking space both in the inner city parking places as well as the authority's Park and Ride sites will also be broadcast to Variable

Message Signs

strategically sited along the road network. This will allow motorists to make informed decisions on alternative routes and/or encourage commuters to use the authority's Park & Ride services.



Central to the Action Plan is the construction of a working, near real-time traffic emissions forecast model ('Nowcaster'). 'Nowcaster' will compute pollution loading along the primary routes every hour – or more frequently if this proves necessary. A communication link with the Variable Message Signs system will broadcast specific messages to specific signs to influence traffic flow.

An emissions database is presently being compiled which will eventually identify and classify every road within the City & County of Swansea. All industrial, point and area sources will be defined and included onto the database.

Detailed information of traffic flow is an essential part of the data



input to the 'Nowcaster' model and 30 solar powered Automatic Traffic Counters (ATCs) have been installed within the Lower Swansea Valley area to provide this data. This information is then transmitted every 5 minutes via the GPRS network to dedicated computer servers.

Meteorological data will be received from the Danish Met Office and will span 3 days as an hourly time series. The forecasts will be updated four times a day.

Real-time air quality data will be processed from the City's existing air quality monitoring stations in the City Centre, Morfa, Morriston and Hafod.



Validation of the output of the 'Nowcaster' model will be achieved by the measurement of real-time air quality and meteorological data along a typical street congested with slow-moving traffic.

Predictive output from 'Nowcaster' will be in colour-coded graphical form on a re-defined digital map. Pollution loading for the various pollutants for each road link will be colour graded and uploaded on an hourly basis together with all air quality data and meteorological forecasts to the Pollution Control web pages. This will provide the general public with visual indications of current pollution levels together with hourly predictions for up to 8 hours into the future.

The ability to forecast conditions ahead, allows an opportunity for management of the traffic flows in the lower valley area and for the traffic to be redirected away from area(s) identified as likely to experience pollution incidents.

Appendix 3

will use data collected from 30 solar panelled Automatic Traffic Counters (ATCs) that have been installed within the area; meteorological data from the Danish Met Office and real-time air quality data from the City's existing air quality monitoring

stations in the City Centre, Morfa, Morriston and Hafod.

It is hoped that this programme will be the forerunner of similar measures to be taken in other areas across the city.



If you would like to tell us your views or require further information then please contact us either

on

01792 635600 Pollution Control Division;

or

e-mail pollution@swansea.gov.uk

or

www.swansea.airqualitydata.com

or

write to Pollution Control Division,

Environment Department,

City and County of Swansea,

The Guildhall, Swansea

SA1 4PE

Summary of Action Plan

Measures

- ❖ Promotion and Provision of Alternatives – travel plans; safer routes to schools; improved walking and cycling facilities; park and ride provision; enhancement of bus and rail stations; improved Internet access to information.
- ❖ Managing The Road Network – enforcement of bus only lanes; improved bus provision; bus corridor enhancement; bus priority routes; intelligent traffic signals; traffic management at pollution 'hot spots'; removal of existing Neath Road traffic management schemes; Improvements at Quay Parade Bridges.
- ❖ Emission Management – roadside testing; promote/ pilot alternative vehicles/ fuels; encourage the use of natural gas for diesel HGVs; city centre car park charging schemes.



CITY AND COUNTY OF SWANSEA
DINAS A SIR ABERTAWE

AIR QUALITY ACTION PLAN FOR SWANSEA



The Environment Act 1995 introduced legislation for the local management of air quality. Part IV of the Act introduced a statutory duty for local authorities to review and assess the air quality within their districts and to identify those areas where further local measures would be required to achieve the air quality standards and objectives.

The National Air Quality Strategy was published in March 1997, establishing standards for certain key pollutants and outlining national and international policies to reduce air pollution levels by 2005.

The Air Quality (Wales) Regulations 2000 set the statutory objectives for local authorities for 7 air pollutants (benzene, 1,3-butadiene, carbon monoxide, lead, nitrogen dioxide (NO₂), fine particles and sulphur dioxide) to be achieved by 2005. The objectives were based on the effect of the pollutant on human health.

The City and County of Swansea undertook a comprehensive multi-staged review and assessment of air quality within its boundaries and was able to identify those

areas that would exceed the national objectives. In 2001 an Air Quality Management Area (AQMA) was declared in the Lower Swansea Valley. This is referred to as the Hafod Air Quality Management Area (NO₂) because Hafod was likely to fail the statutory NO₂ objective, which was to be achieved by 2005.

In order to improve air quality within an AQMA a specific **Action Plan** is required.

After several feasibility studies and a lot of preparatory work Swansea are now satisfied that the outcome of the Action Plan will provide a practical delivery of the improvements required.



A summary of the **proposed measures** being considered or those, which are being pursued actively, have been provided on the back of this document.

As part of its **Action Plan** the Council is introducing a traffic management programme

to both improve traffic flow and reduce pollution in the AQMA.

The main traffic routes through the AQMA are also the major commuter links to the city centre. It is planned that, when the programme is in place, motorists using these routes will be advised in advance not only of traffic congestion, but also of pollution levels along the route. Available car parking space both in the inner city parking places as well as the authority's Park and Ride sites will also be broadcast to



Variable Message Signs strategically sited along the road network. This will allow drivers to make informed decisions on alternative routes and/or encourage commuters to use the authority's **Park & Ride** services.

Central to the Action Plan is the traffic



emissions forecast model '**Nowcaster**'. This model will predict the level of pollution along the main traffic routes in the AQMA. It